



US007751948B2

(12) **United States Patent**  
**Boorman et al.**

(10) **Patent No.:** **US 7,751,948 B2**  
(45) **Date of Patent:** **Jul. 6, 2010**

(54) **APPARATUSES AND METHODS FOR DISPLAYING AND RECEIVING TACTICAL AND STRATEGIC FLIGHT GUIDANCE INFORMATION**

4,196,474 A 4/1980 Buchanan et al.  
4,212,064 A 7/1980 Forsythe  
4,224,669 A 9/1980 Brame  
4,247,843 A 1/1981 Miller

(Continued)

(75) Inventors: **Daniel J. Boorman**, Seattle, WA (US);  
**John C. Griffin, III**, University Place, WA (US);  
**Peter D. Gunn**, Bellevue, WA (US);  
**Randall J. Mumaw**, Seattle, WA (US)

**FOREIGN PATENT DOCUMENTS**

DE 3315386 A 10/1984  
EP 0 286 120 10/1986  
EP 0 370 640 5/1990  
EP 0 489 521 6/1992  
EP 1273987 1/2003

(Continued)

(73) Assignee: **The Boeing Company**, Chicago, IL (US)

(\* ) Notice: Subject to any disclaimer, the term of this patent is extended or adjusted under 35 U.S.C. 154(b) by 38 days.

**OTHER PUBLICATIONS**

Hutchins, Edwin, "The Integrated Mode Management Interface," Department of Cognitive Science, University of California, San Diego, Sep. 17, 1996.

(Continued)

(21) Appl. No.: **11/639,791**

(22) Filed: **Dec. 14, 2006**

(65) **Prior Publication Data**

US 2008/0091311 A1 Apr. 17, 2008

**Related U.S. Application Data**

(62) Division of application No. 10/746,912, filed on Dec. 24, 2003, now Pat. No. 7,188,007.

(51) **Int. Cl.**  
**B64C 23/00** (2006.01)

(52) **U.S. Cl.** ..... **701/3; 701/4; 701/14; 340/945; 244/75.1**

(58) **Field of Classification Search** ..... **701/3, 701/4, 11, 14-16, 120-123; 340/945, 947, 340/971-980; 244/75.1, 76 R, 183, 189-190**  
See application file for complete search history.

(56) **References Cited**

**U.S. PATENT DOCUMENTS**

3,191,147 A 6/1965 Majendie  
3,696,671 A 10/1972 Steigleder et al.

*Primary Examiner*—Gertrude Arthur Jeanglaude  
(74) *Attorney, Agent, or Firm*—Perkins Coie LLP

(57) **ABSTRACT**

Methods and apparatuses for displaying and receiving tactical and strategic flight guidance information are disclosed. A method in accordance with one aspect of the invention includes displaying at least one first indicator to an operator of the aircraft, with a first indicator corresponding to a first instruction input by the operator for directing a first aircraft behavior and implemented upon receiving an activation instruction from the operator. At least one second indicator corresponding to a second instruction for directing a second aircraft behavior at least proximately the same as the first aircraft behavior is displayed, with the at least one second instruction to be automatically implemented at a future time. The at least one second indicator is at least approximately the same as the at least one first indicator. Indicators can be hierarchically organized to simplify presentation and reduce pilot training time.

**14 Claims, 16 Drawing Sheets**

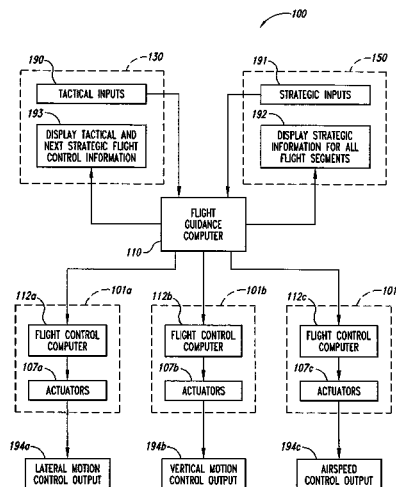

2005/0228674 A1 10/2005 Gunn et al.  
2005/0231390 A1 10/2005 Crane et al.  
2005/0283305 A1 12/2005 Clark et al.  
2006/0004496 A1 1/2006 Tucker et al.  
2006/0004498 A1 1/2006 Gunn et al.  
2006/0005147 A1 1/2006 Hammack et al.  
2006/0220914 A1 10/2006 Sikora et al.

FOREIGN PATENT DOCUMENTS

FR 2817831 6/2002  
FR 2848306 6/2004  
GB 886136 1/1962  
WO WO-02/24530 3/2002  
WO WO-2004/027732 4/2004

OTHER PUBLICATIONS

Lindenfeld, "What is an FMS?", Flight Management Systems (5 pages); <http://www.ultranet.com/~marzgold//FAQ-FMS.html> [Accessed Jun. 3, 2002].

Meriweather's Flight Deck Acronyms & Definitions (4 pages); <http://www.meriweather.com/fd/def.html>; [Accessed Jun. 3, 2002].

Peugeot 406 Handbook, Automobiles Peugeot, Paris, France, May 14, 1998 (pp. 30 and 38).

777 Flight Deck (1 page); [http://www.meriweather.com/777/777\\_13main.html](http://www.meriweather.com/777/777_13main.html); [Accessed Jan. 28, 2003].

Painter et al., "Decision Support For the General Aviation Pilot," Systems, Man, and Cybernetics, IEEE International Conference on Computational Cybernetics and Simulation, Orlando, FL, Oct. 12-15, 1997, pp. 88-93.

NASA, F-18 Cockpit, 1995, <<http://www.dfrc.nasa.gov/gallery/Photo/F-18Chase/Medium/EC95-43155-7.jpg>>, accessed Aug. 14, 2007.

Deltasoft, F-15 Cockpit, Aug. 2001, <<http://web.archive.org/web/20010803031953/http://deltasoft.fife.wa.us/cockpit.htm>> accessed Aug. 14, 2007.

U.S. Appl. No. 12/629,007, filed Dec. 1, 2009, Boorman.

\* cited by examiner

LATERAL MOTION MODES

LNAV  
TRK SEL  
TRK HOLD  
LOC  
TO/GA  
  
HDG SEL  
HDG HOLD  
  
ATT  
  
ROLLOUT

VERTICAL MOTION MODES

TO/GA  
VNAV SPD  
FLCH SPD  
V/S  
VNAV PTH  
G/S  
FPA  
  
VNAV ALT  
ALT  
  
FLARE

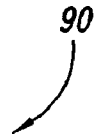

*Fig. 1B*  
*(Prior Art)*

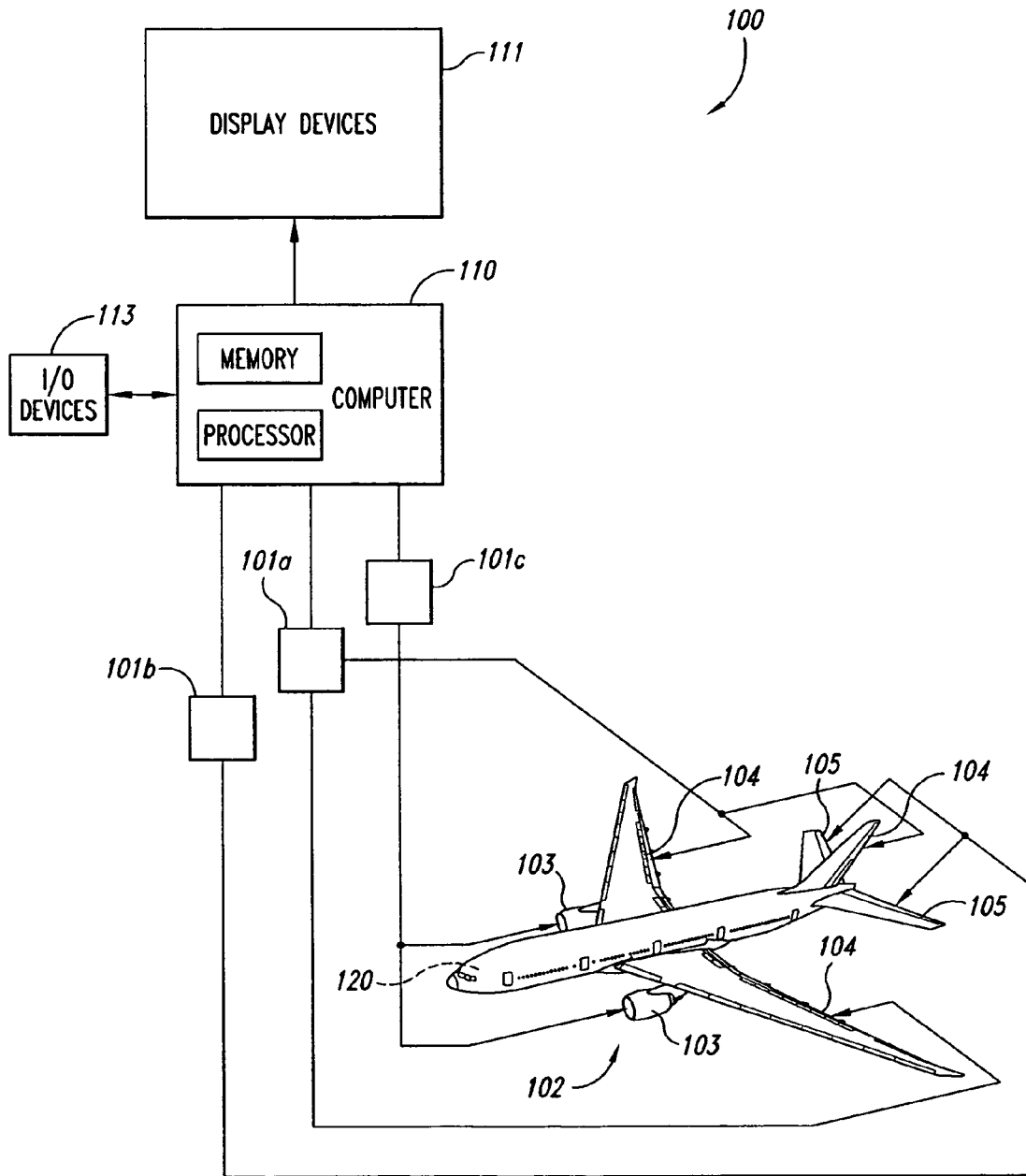

Fig. 2A

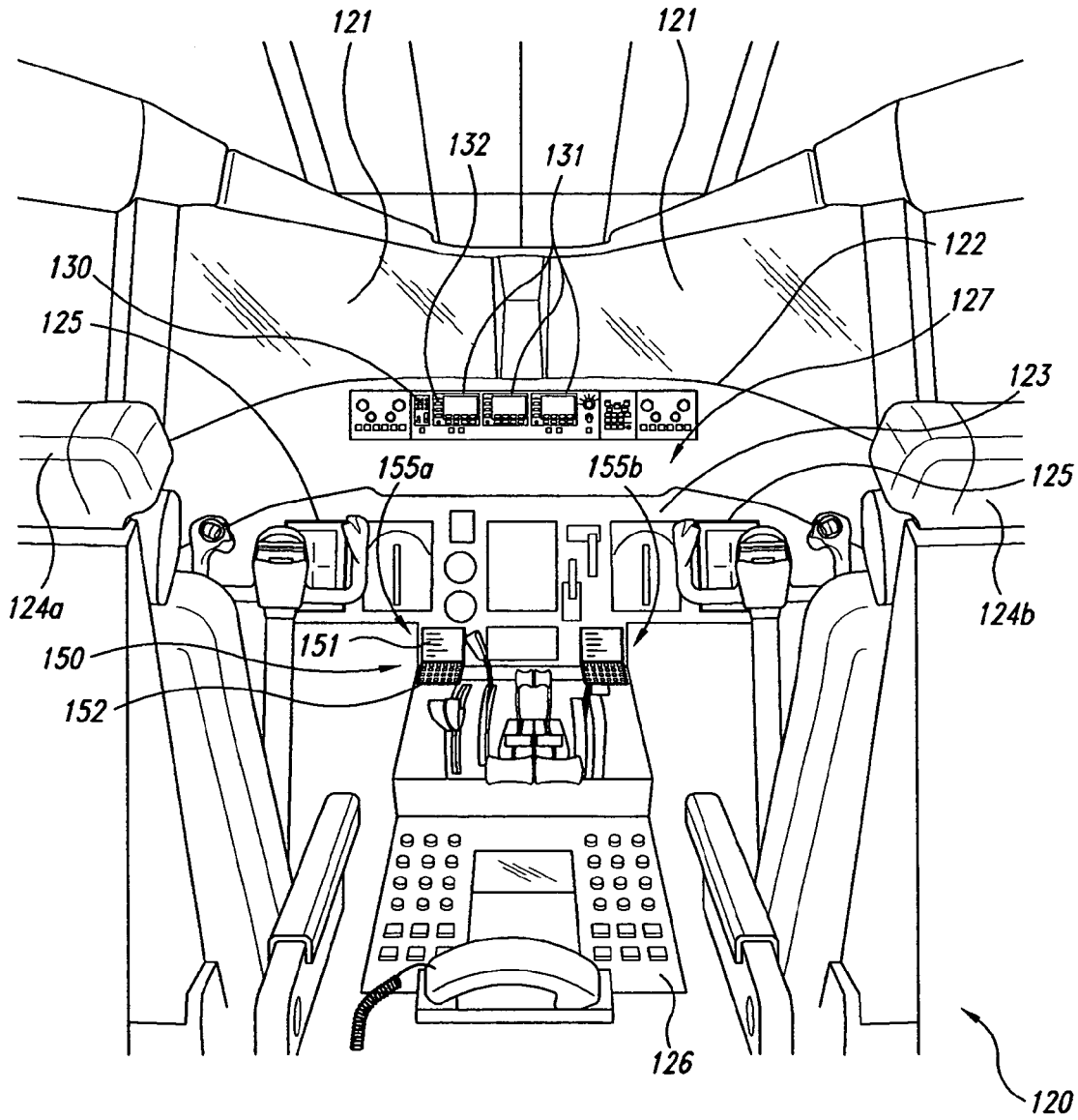

Fig. 2B

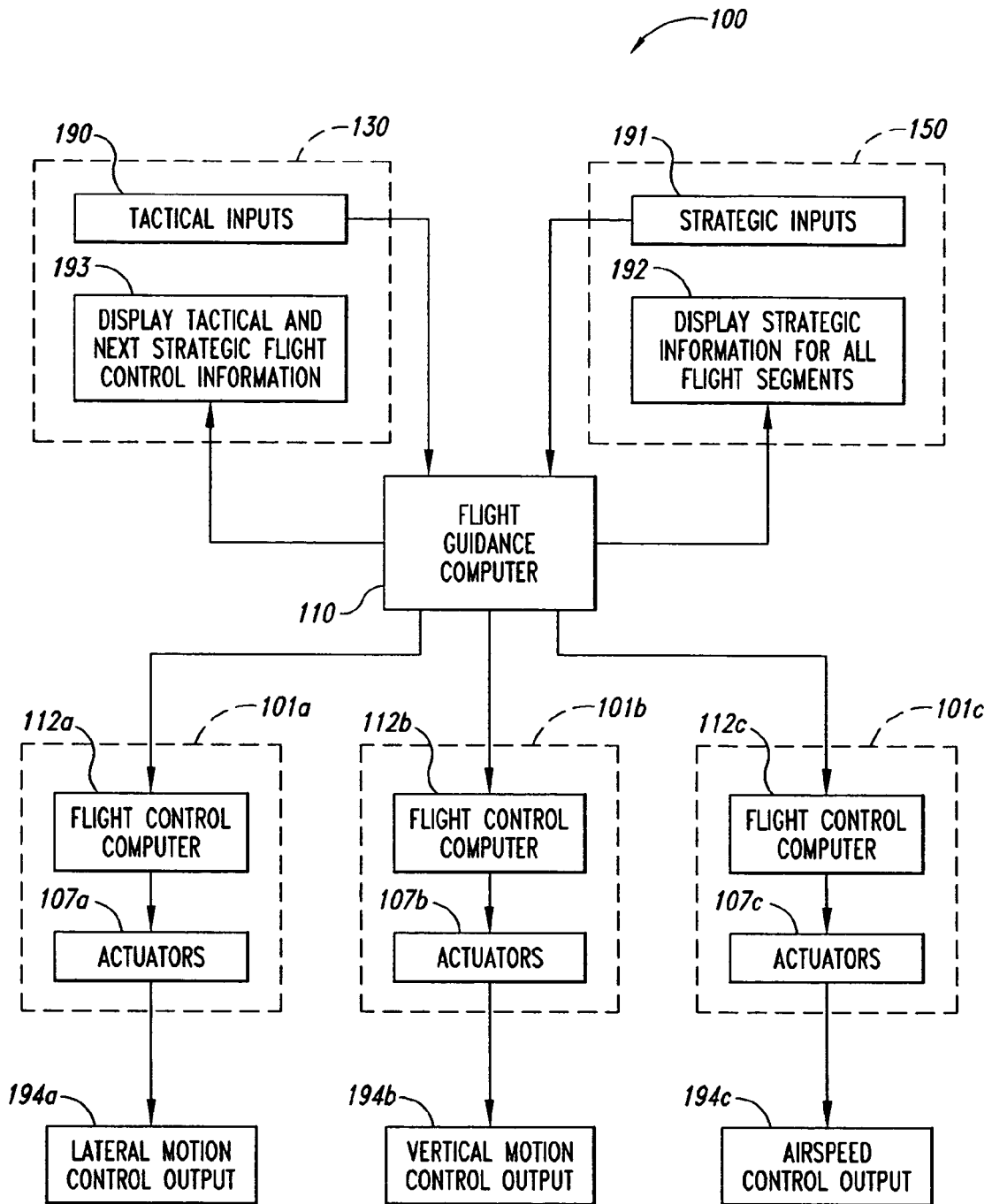
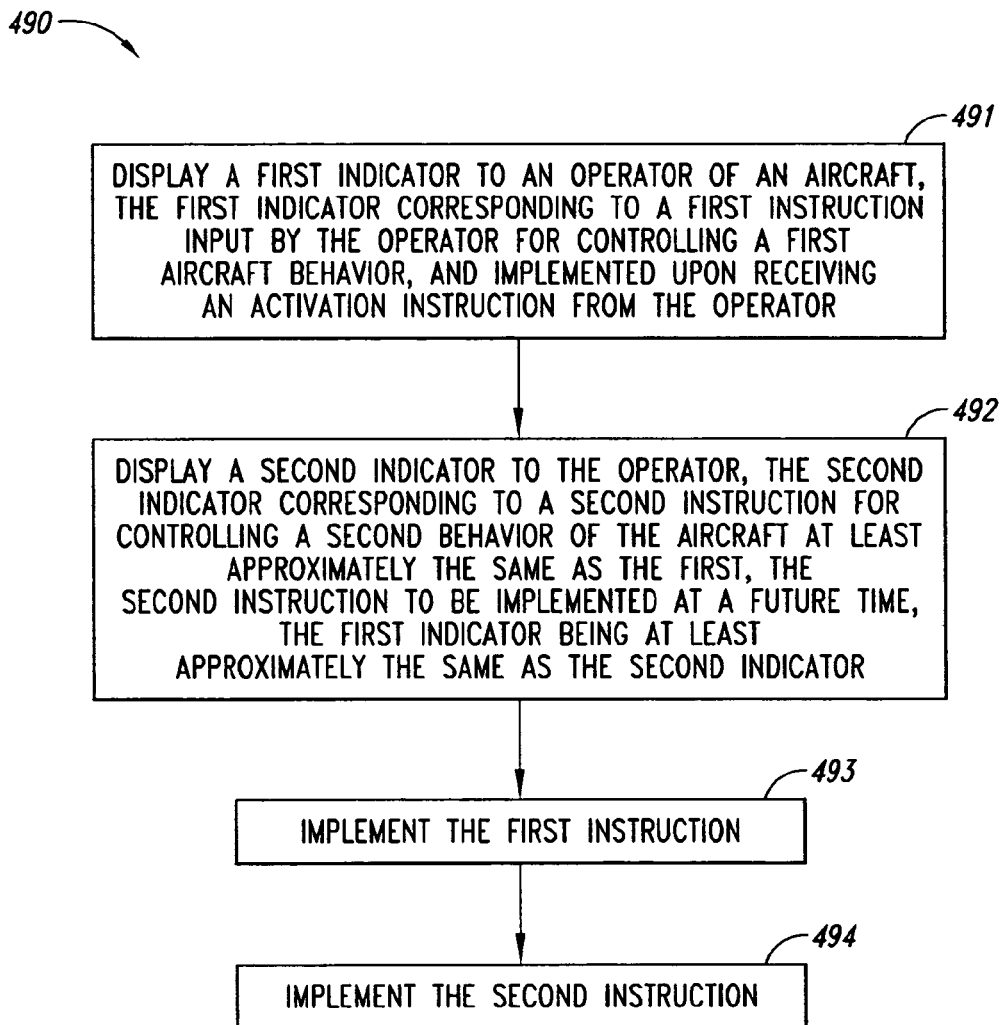
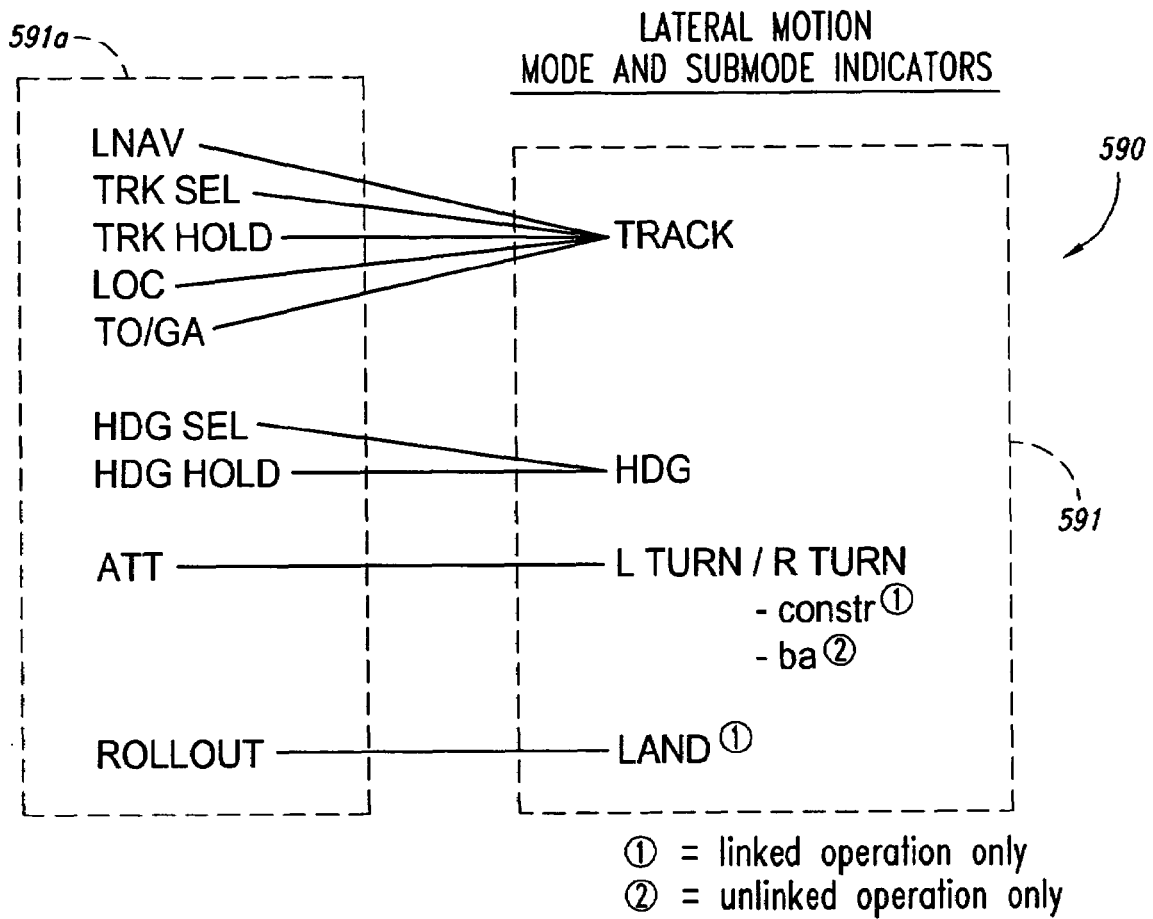

Fig. 3



*Fig. 4*



*Fig. 5*



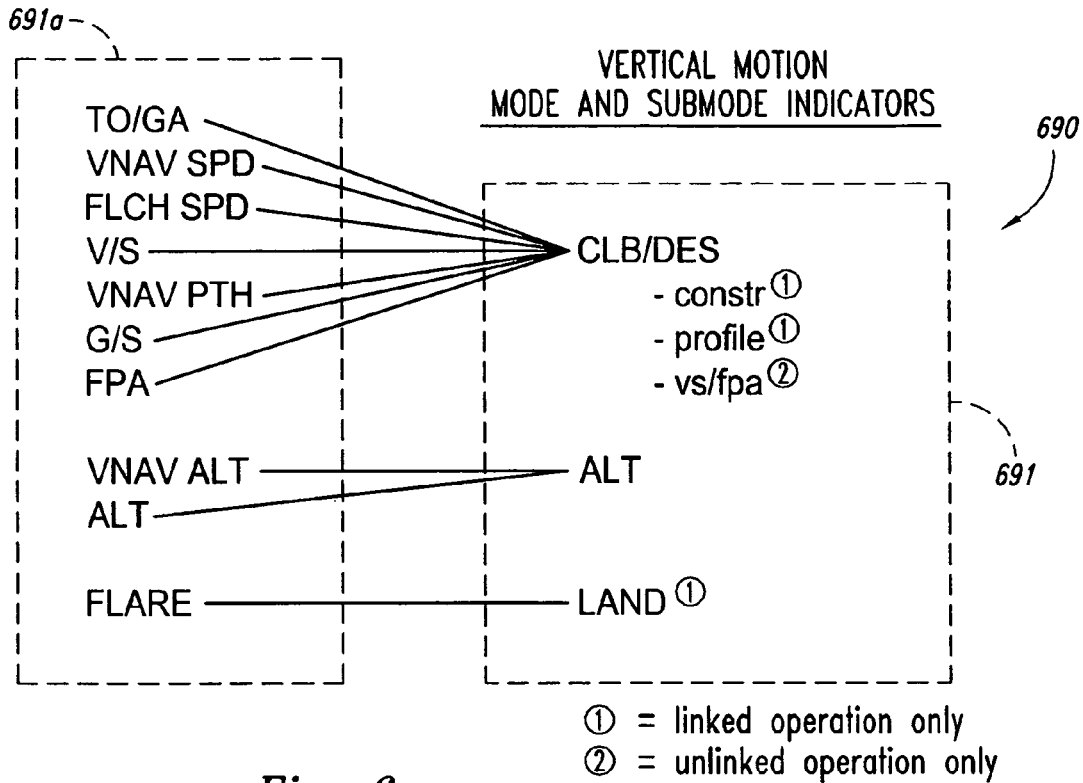

Fig. 6

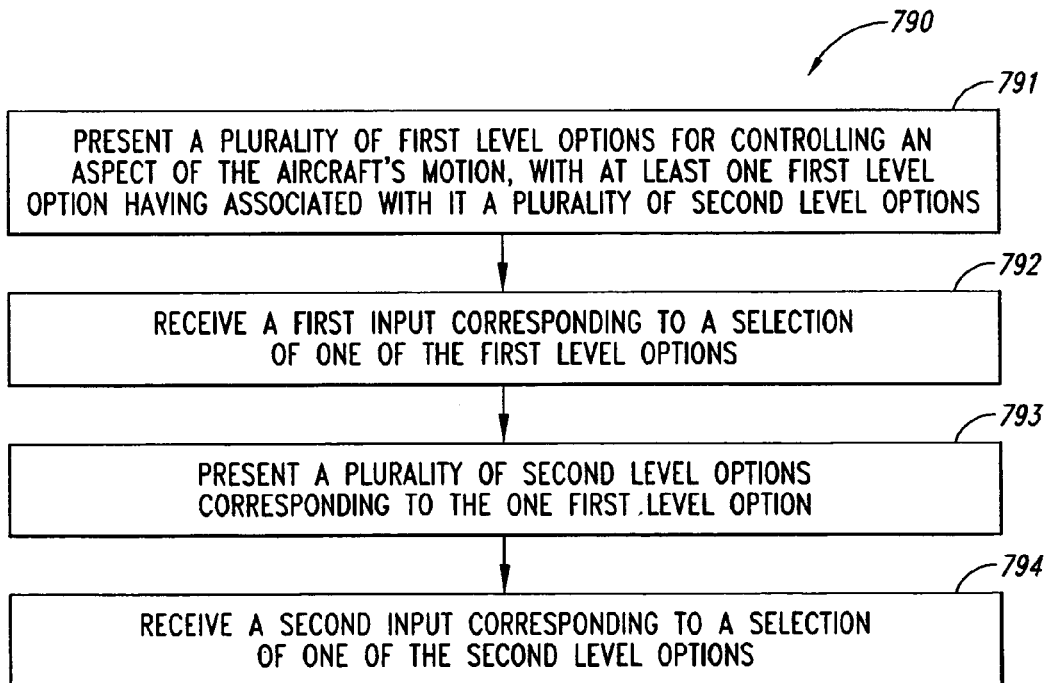

Fig. 7

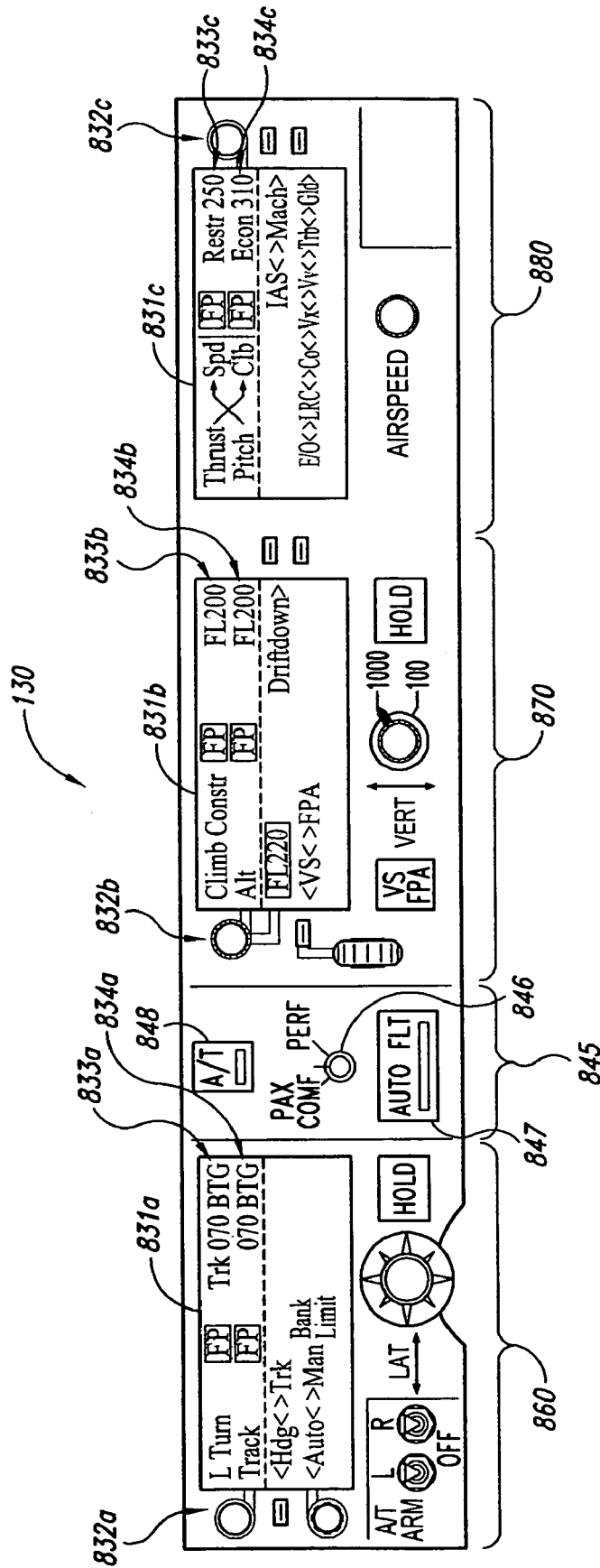

Fig. 8

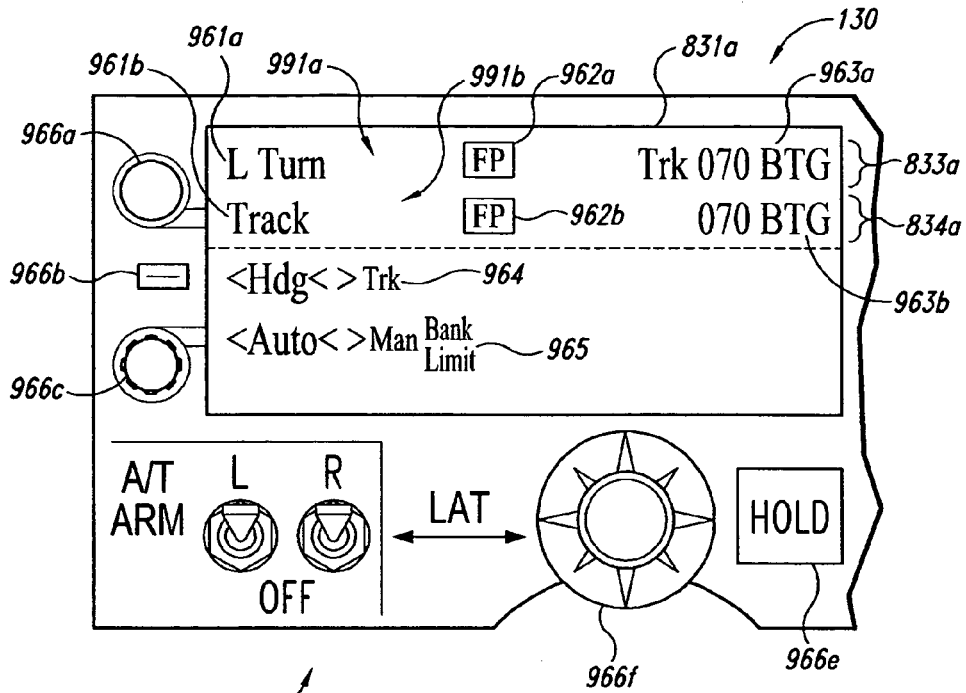

Fig. 9A

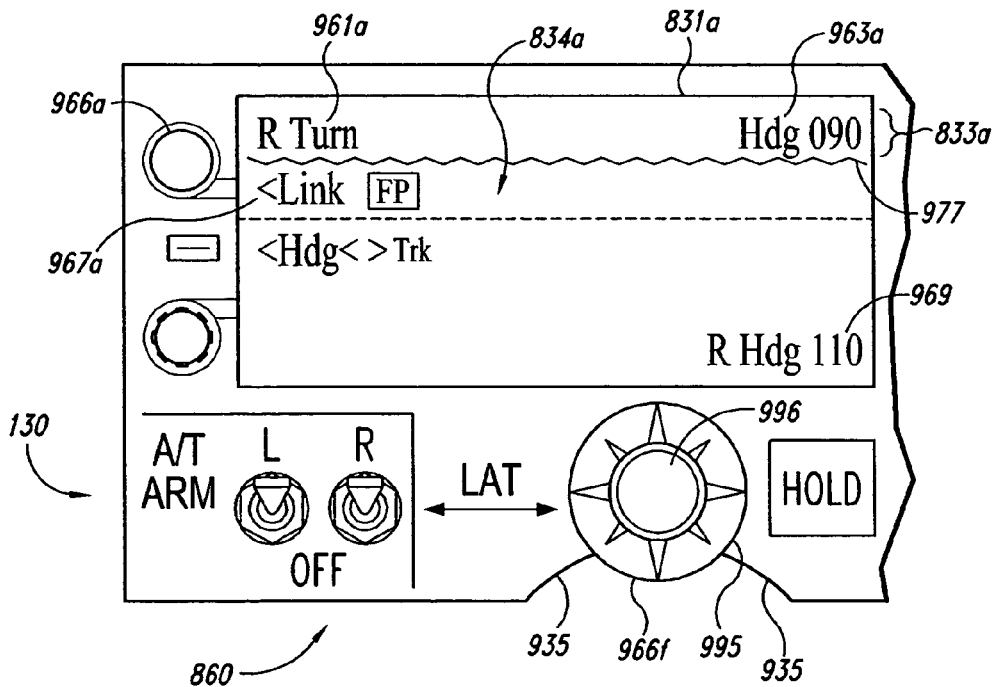

Fig. 9B

3

FIG. 1B illustrates existing flight mode annunciators in accordance with the prior art.

FIG. 2A is a schematic illustration of an aircraft having a flight guidance system in accordance with an embodiment of the invention.

FIG. 2B is a partially schematic illustration of a flight deck having a flight guidance system with displays and controls configured in accordance with an embodiment of the invention.

FIG. 3 is a block diagram illustrating in a general manner the operation of a flight guidance system in accordance with an embodiment of the invention.

FIG. 4 is a block diagram illustrating a method for displaying indicators for automatically controlling the motion of an aircraft in accordance with an embodiment of the invention.

FIG. 5 is an illustration of lateral motion modes in accordance with an embodiment of the invention, along with existing lateral motion modes.

FIG. 6 is an illustration of vertical motion modes in accordance with an embodiment of the invention, along with existing vertical motion modes.

FIG. 7 is a flow diagram illustrating a method for presenting control information and receiving control inputs at two different hierarchical levels in accordance with an embodiment of the invention.

FIG. 8 is a front elevation view of a mode control panel having displays and controls arranged in accordance with an embodiment of the invention.

FIGS. 9A-9B illustrate a portion of the mode control panel shown in FIG. 8 for controlling lateral motion of an aircraft in accordance with an embodiment of the invention.

FIGS. 10A-10B illustrate a portion of the mode control panel shown in FIG. 8 for controlling vertical motion of an aircraft in accordance with an embodiment of the invention.

FIGS. 11A-11B illustrate a portion of the mode control panel shown in FIG. 8 for controlling the airspeed of an aircraft in accordance with an embodiment of the invention.

FIG. 12 is a flow diagram illustrating a method for arranging and displaying flight control information in accordance with another embodiment of the invention.

FIG. 13 is a flow diagram illustrating a method for displaying current and proposed subsequent flight control information in accordance with still another embodiment of the invention.

FIGS. 14A-14B are partially schematic illustrations of a mode control panel and flight plan list display, both of which have flight control information displayed in similar manners, in accordance with an embodiment of the invention.

#### DETAILED DESCRIPTION

The following disclosure describes apparatuses and methods for receiving, displaying and implementing flight guidance information associated with the control of aircraft. Certain specific details are set forth in the following description and in FIGS. 2A-14B to provide a thorough understanding of various embodiments of the invention. Well-known structures, systems and methods often associated with aircraft flight guidance systems have not been shown or described in detail below to avoid unnecessarily obscuring the description of the various embodiments of the invention. In addition, those of ordinary skill in the relevant art will understand that additional embodiments of the present invention may be practiced without several of the details described below.

Many embodiments of the invention described below may take the form of computer-executable instructions, such as routines executed by a programmable computer (e.g., a flight

4

guidance computer). Those skilled in the relevant art will appreciate that the invention can be practiced on other computer system configurations as well. The invention can be embodied in a special-purpose computer or data processor that is specifically programmed, configured or constructed to perform one or more of the computer-executable instructions described below. Accordingly, the term "computer" as generally used herein refers to any data processor and can include Internet appliances, hand-held devices (including palmtop computers, wearable computers, cellular or mobile phones, multi-processor systems, processor-based or programmable consumer electronics, network computers, mini-computers and the like).

The invention can also be practiced in distributed computing environments, where tasks or modules perform by remote processing devices that are linked through a communications network. In a distributed computing environment, program modules or subroutines may be located in both local and remote memory storage devices. Aspects of the invention described below may be stored or distributed on computer-readable media, including magnetic and optically readable and removable computer disks, as well as distributed electronically over networks. Data structures and transmissions of data particular to aspects of the invention are also encompassed within the scope of the invention.

FIG. 2A is a schematic illustration of an aircraft 102 having a flight guidance system 100 configured in accordance with an embodiment of the invention. In one aspect of this embodiment, the flight guidance system 100 can include a flight guidance computer 110 linked to one or more control systems 101, shown in FIG. 2A as a lateral motion or roll control system 101a, a vertical motion or pitch control system 101b, and an airspeed or engine control system/autothrottle 101c. The lateral motion control system 101a can be coupled to lateral control surfaces 104 (e.g., the ailerons and/or rudder of the aircraft 102). The vertical motion controller 101b can be coupled to pitch control surfaces 105 of the aircraft 102 (e.g., the aircraft elevators). The airspeed controller 101c can be coupled to engines 103 of the aircraft 102.

The flight guidance computer 110 can include a memory and a processor, and can be linked to one or more display devices 111, I/O devices 113 and/or other computers of the system 100, as described in greater detail below. The I/O devices 113 can be housed in a flight deck 120 of the aircraft 102, and can be used by the pilot or other operator to provide instructions to the flight guidance system 100. Instructions can also be provided via telemetry from ground-based stations, or via satellite, data link or gate link. Accordingly, the flight guidance computer 110 can include a receiver portion that receives inputs from an operator or another source, a processor portion that processes signals (e.g., input signals) and/or a display portion that displays information (e.g., to the operator).

FIG. 2B is a forward elevational view of an embodiment of the flight deck 120 shown in FIG. 2A. In one aspect of this embodiment, the flight deck 120 includes forward windows 121 providing a forward field of view out of the aircraft 102 (FIG. 2A) for operators seated in a first seat 124a and/or a second seat 124b. In other embodiments, the forward windows 121 can be replaced by one or more external vision screens that include a visual display of a forward field of view out of the aircraft 102. A glare shield 122 can be positioned adjacent to the forward windows 121 to reduce glare on one or more flight instruments 127 positioned on a control pedestal 126 and a forward instrument panel 123.

The flight instruments 127 can include primary flight displays (PFDs) 125 that provide the operators with actual flight

15

As described above, another feature of the system **100** is that it can allow the operator to preview instructions when controlling the aircraft in an unlinked manner, before committing to having the instructions implemented. FIG. **13** is a flow diagram illustrating a process **1390** corresponding to this arrangement. The process **1390** can include displaying a current target to which the aircraft is currently being directed at a first display location (process portion **1391**) and receiving an input for a proposed subsequent target (process portion **1392**). The input for the proposed subsequent target can be provided by the operator (e.g., at the mode control panel **130** or the flight management computer **150**), or by other sources (e.g., via a datalink). The proposed subsequent target and, optionally the sense of the target can be displayed at a second display location (e.g., at a preview display window) simultaneously with displaying the current target (process portion **1393**). In one aspect of this embodiment, the preview display window initially displays the current target, and then updates the value shown as the input is received. In process portion **1394**, the process **1390** includes receiving an input authorizing implementation of the subsequent target (e.g., when the pilot presses a button on the mode control panel **130**). The display of the current target at the first display location is then replaced with a display of the subsequent target at the first display location (process portion **1395**).

An advantage of the arrangement described above with reference to FIG. **13** is that, when the aircraft is operating in an unlinked mode, the pilot can preview the target to which he will subsequently direct the aircraft, while viewing the target to which the aircraft is currently being directed and before committing to the new target. This arrangement can reduce pilot confusion by clearly delineating between a target to which the aircraft is currently being directed and a proposed new target to which the aircraft may or may not subsequently be directed, depending on whether the operator authorizes implementing the new target.

FIG. **14A** is a simplified, partially schematic illustration of portions of the mode control panel **130** and the flight plan list display **151**, configured to display information during unlinked operation in accordance with an embodiment of the invention. In one aspect of this embodiment, both the mode control panel **130** and the flight plan list display **151** include displays of flight control information arranged in three columns: a first column corresponding to lateral motion, a second column corresponding to vertical motion, and a third column corresponding to the airspeed of the aircraft. The mode control panel **130** displays the current control indicators **833** (shown as current lateral control indicators **833a**, current vertical control indicators **833b**, and current airspeed control indicators **833c**), each of which includes a corresponding current target indicators **963a**, **1073a**, **1183a**, respectively. The mode control panel **130** also displays the next control indicators **834** (shown as next lateral control indicators **834a**, next vertical control indicators **834b**, and next airspeed control indicators **834c**), with no next targets shown because the operation is unlinked. Unlink indicators **977**, **1077a** and **1177** also highlight the unlinked aspect of the operation.

At least some of the same information (e.g., the targets) displayed on the mode control panel **130** can be presented on the flight plan list display **151**. In a particular aspect of this embodiment, the flight plan list display **151** can include the current control indicators **833a**, **833b**, **833c** even if these indicators correspond to instructions input at the mode control panel **130** for unlinked operation. In a particular aspect of this embodiment, information corresponding to linked operation can be visually separated from information corresponding to unlinked operation, e.g., by a marker **1455** or by use of different colors or fonts. The flight plan list display **151** also includes subsequent control indicators **1453** for flight plan legs to be executed subsequently to the current flight plan leg.

16

FIG. **14B** illustrates the mode control panel **130** and the flight plan list display **151** during linked operation. The unlink indicators **977**, **1077**, and **1177** (FIG. **14A**) are not displayed on the mode control panel **130** while the next targets **963b**, **1073b** and **1183b** are displayed, all of which signifies linked operation. The flight plan list display **151** does not display the marker **1455** (FIG. **14A**), which further signifies linked operation.

One feature of an embodiment of the arrangement described above with reference to FIGS. **14A-14B** is that the information shown on the mode control panel **130** matches, or at least approximately matches, the information shown on the flight plan list display **151**, in organization, content or both. Accordingly, operators need not learn to recognize different indicators (or different ordering of indicators) that may correspond to similar or identical flight control instructions. Another feature of this embodiment is that the operator can see both tactical (unlinked) and strategic (linked) information at the same display.

In yet another embodiment, the aircraft can include an altitude alerting system that is directly coupled to the flight guidance computer **110** (FIG. **2A**). Accordingly, the altitude alerting system can be coupled to inputs received by and/or displayed at the mode control panel **130**, and/or displayed at the flight plan list display **151**. In a particular embodiment, the altitude alerting system can be triggered by deviations from the target altitude (e.g., the current target altitude for a level flight maneuver during climb, descent or cruise), automatically displayed at the flight plan list display **151** and pre-programmed into the flight guidance computer **110**. If the current altitude of the aircraft differs from the target altitude by more than predetermined amount, the system can alert the operator, e.g., via a visual and/or aural notification. This is unlike some existing systems where the altitude alerting system is triggered by deviation from an altitude value that is manually input by the operator and displayed at a separate altitude window.

As described above with reference to FIG. **10A**, the mode control panel **130** can include a limit altitude display **1075** at which the operator can display clearance limit altitudes (e.g., as imposed by air traffic control) during flight, by rotating the link switch **1076a**. Accordingly, the clearance altitude limit can represent an altitude at which the aircraft will level off, e.g., through operation of the flight management computer **150** or the autopilot. The operator can also de-activate the clearance limit by blanking the limit altitude display **1075**, which is unlike existing systems, and which allows the operator additional flexibility. In particular, the operator can activate the clearance limit altitude, set the desired value, and deactivate the value when it is no longer used. In one aspect of this embodiment, the aircraft altitude is then controlled by the flight segments pre-programmed into the flight management computer **150**. A visual indicator (e.g., the color of the display **1035**) can indicate to the operator whether or not the clearance limit is available or active or inactive. In one aspect of this embodiment, this feature is available only during linked operation.

If the clearance limit value represents the next level-off altitude in the flight plan (during climb or descent), it becomes the current vertical target. Accordingly, it is displayed at the current target indicator **1073a** on the mode control panel **130** and is also shown at the appropriate line of the flight plan list at the flight plan list display **151**. In a particular aspect of this embodiment, the flight segments or legs subsequent to the clearance limit are highlighted to indicate that they are not yet cleared (e.g., by providing a visual separator between cleared and uncleared segments, and/or by providing cleared segments in a different color than uncleared segments).

If the clearance limit value represents a level-off that occurs after the next level-off in the flight plan (during climb

or descent), it is shown in the appropriate line of the flight plan list on the flight plan list display **151**, and the remaining legs of the flight plan are indicated to be uncleared. As the operator then changes the clearance limit value at the limit altitude display **1075**, the flight plan list display **151** is automatically updated to indicate new cleared legs (as appropriate) and the clearance value is inserted into the flight plan list display **151**. If the aircraft operation is subsequently unlinked, the clearance limit is deleted and, in one embodiment, is not automatically reinstated if linked operation subsequently is reactivated. An advantage of the foregoing arrangement is that the operator can clearly see by reference to the flight plan list display **151** which legs are cleared and which are not. This arrangement can be particularly useful when a clearance limit results in multiple flight legs being cleared.

From the foregoing, it will be appreciated that specific embodiments of the invention have been described herein for purposes of illustration, but that various modifications may be made without deviating from the spirit and scope of the invention. Additional related embodiments are disclosed in co-pending U.S. application Ser. No. 10/746,912, entitled "Apparatuses and Methods for Displaying and Receiving Tactical and Strategic Flight Guidance Information," filed concurrently herewith and incorporated herein in its entirety by reference. Accordingly, the invention is not limited except as by the appended claims.

We claim:

**1.** A computer-implemented method for controlling an aircraft, comprising:

presenting a plurality of first level options for controlling an aspect of the aircraft's motion, at least one of the first level options having associated with it a plurality of second level options;

receiving a first input corresponding to a selection of the at least one first level option;

presenting a plurality of second level options corresponding to the at least one first level option; and

receiving a second input corresponding to a selection of one of the second level options,

wherein during unlinked operation, an instruction corresponding to at least one of the first and second inputs is implemented in response to an operator request, and during linked operation, the instruction is incorporated into a flight plan of the aircraft for automatic execution at a future time, and

wherein at least one of the first or second level options is displayed when the aircraft is engaged in linked operation and hidden when the aircraft is engaged in unlinked operation.

**2.** The method of claim **1**, further comprising:

displaying the first level options on a display panel; and changing a characteristic of a display of the at least one first level option after receiving a first input corresponding to a selection of the at least one first level option.

**3.** The method of claim **1** wherein presenting a plurality of first level options includes presenting at least two of the first level options at a display as a switch is manipulated.

**4.** The method of claim **1** wherein presenting a plurality of second level options includes providing at least two of the second level options as text messages on a display panel.

**5.** The method of claim **1** wherein presenting a plurality of second level options includes providing temporally sequential alphanumeric indications of the second level options as the operator manipulates a switch.

**6.** The method of claim **1** wherein presenting a plurality of first level options includes providing a first set of first level options for controlling a lateral motion of the aircraft, a sec-

ond set of first level options for controlling a vertical motion of the aircraft, and a third set of first level options for controlling a speed of the aircraft.

**7.** The method of claim **1** wherein presenting a plurality of first level options includes presenting a plurality of flight modes in accordance with which the motion of the aircraft may be controlled, and wherein presenting a plurality of second level options includes presenting a plurality of flight submodes in accordance with which the motion of the aircraft may be controlled.

**8.** The method of claim **7** wherein the flight modes correspond to alternate manners in which the aircraft is directed to a target, and wherein at least one of the flight modes includes multiple alternate flight submodes, each of which is associated with the at least one flight mode.

**9.** An aircraft system including a computer-readable medium having contents that perform a method, comprising: presenting a plurality of first level options for controlling an aspect of the aircraft's motion, at least one of the first level options having associated with it a plurality of second level options;

receiving a first input corresponding to a selection of the at least one first level option;

presenting a plurality of second level options corresponding to the at least one first level option; and

receiving a second input corresponding to a selection of one of the second level options,

wherein during unlinked operation, an instruction corresponding to at least one of the first and second inputs is implemented in response to an operator request, and during linked operation, the instruction is incorporated into a flight plan of the aircraft for automatic execution at a future time, and

wherein at least one of the first or second level options is displayed when the aircraft is engaged in linked operation and hidden when the aircraft is engaged in unlinked operation.

**10.** The system of claim **7** wherein the contents of the computer-readable medium are configured to:

display the first level options on a display panel; and change a characteristic of a display of the at least one first level option after receiving a first input corresponding to a selection of the at least one first level option.

**11.** The system of claim **7** wherein the contents of the computer-readable medium are configured to present a plurality of second level options to include at least two of the second level options as text messages on a display panel.

**12.** The system of claim **7** wherein the contents of the computer-readable medium are configured to present a plurality of first level options to include a first set of first level options for controlling a lateral motion of the aircraft, a second set of first level options for controlling a vertical motion of the aircraft, and a third set of first level options for controlling a speed of the aircraft.

**13.** The system of claim **9** wherein presenting a plurality of first level options includes presenting a plurality of flight modes in accordance with which the motion of the aircraft may be controlled, and wherein presenting a plurality of second level options includes presenting a plurality of flight submodes in accordance with which the motion of the aircraft may be controlled.

**14.** The system of claim **13** wherein the flight modes correspond to alternate manners in which the aircraft is directed to a target, and wherein at least one of the flight modes includes multiple alternate flight submodes, each of which is associated with the at least one flight mode.

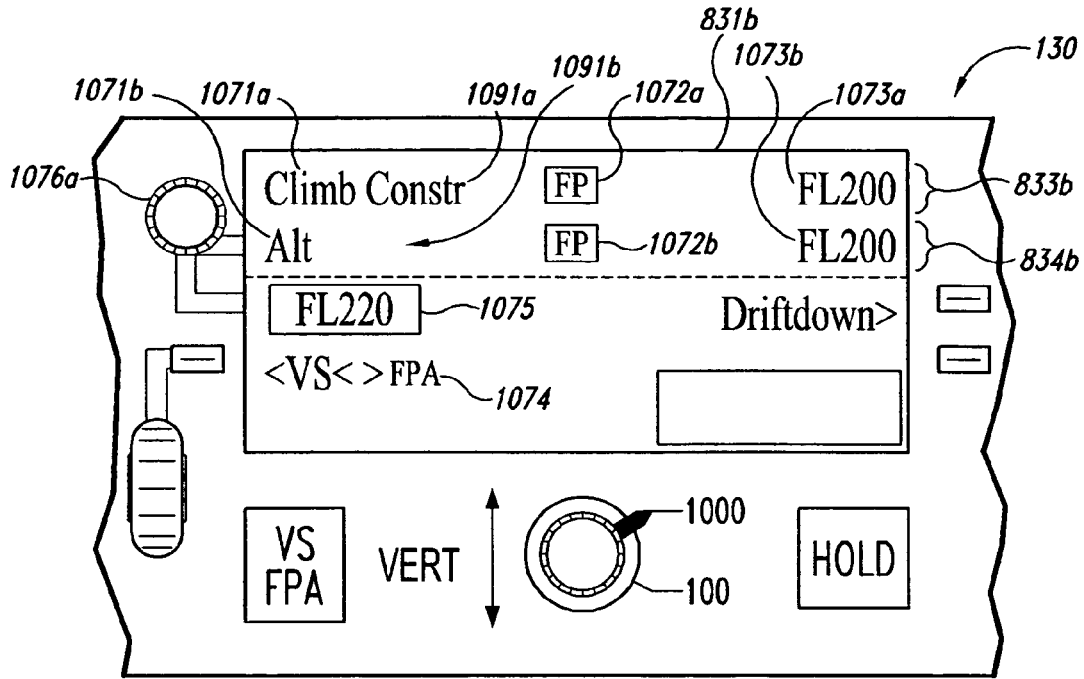

Fig. 10A

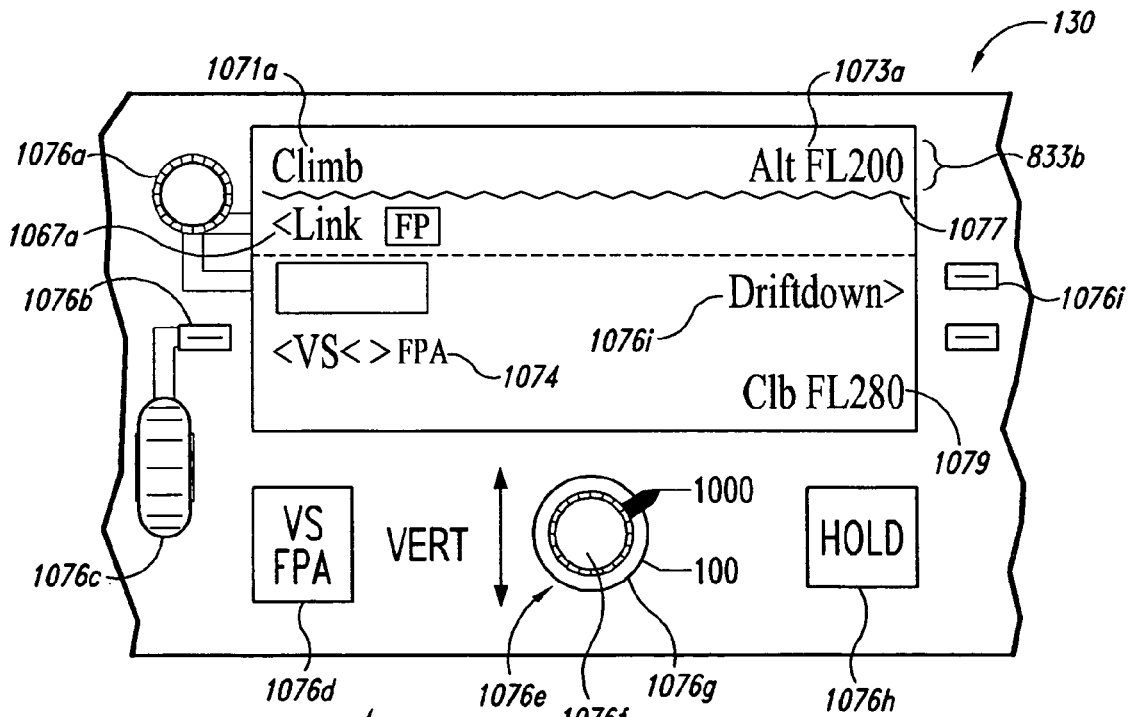
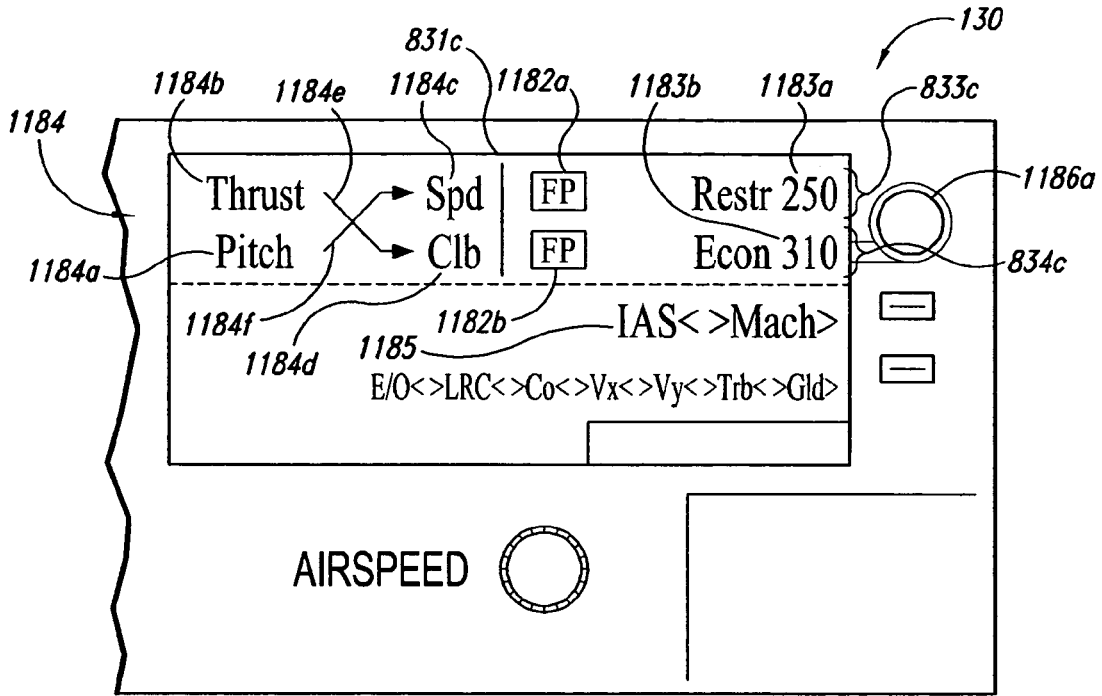
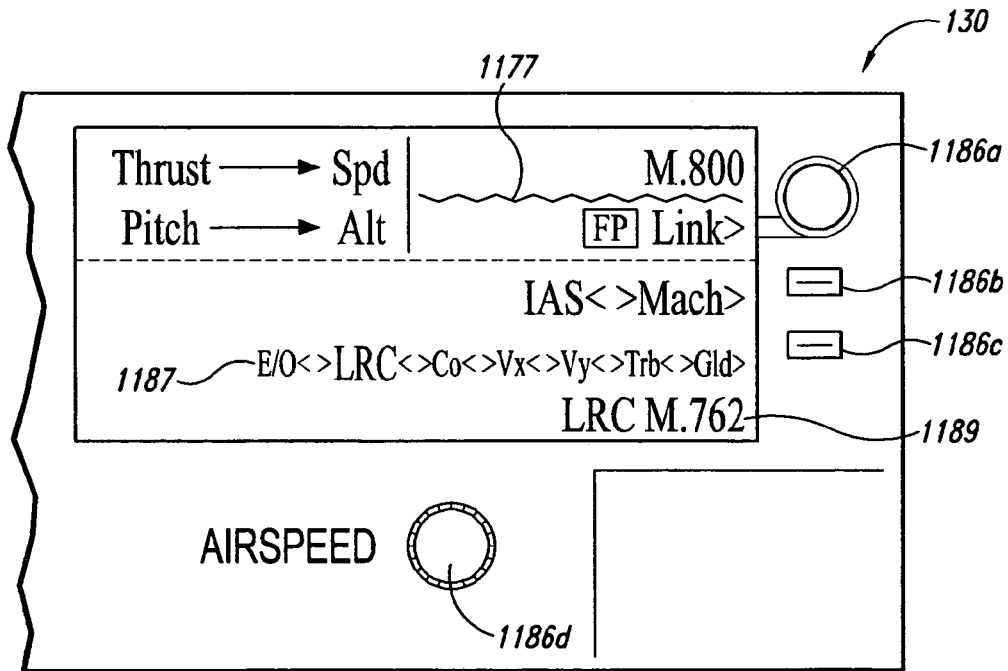

Fig. 10B



880 Fig. 11A



880 Fig. 11B

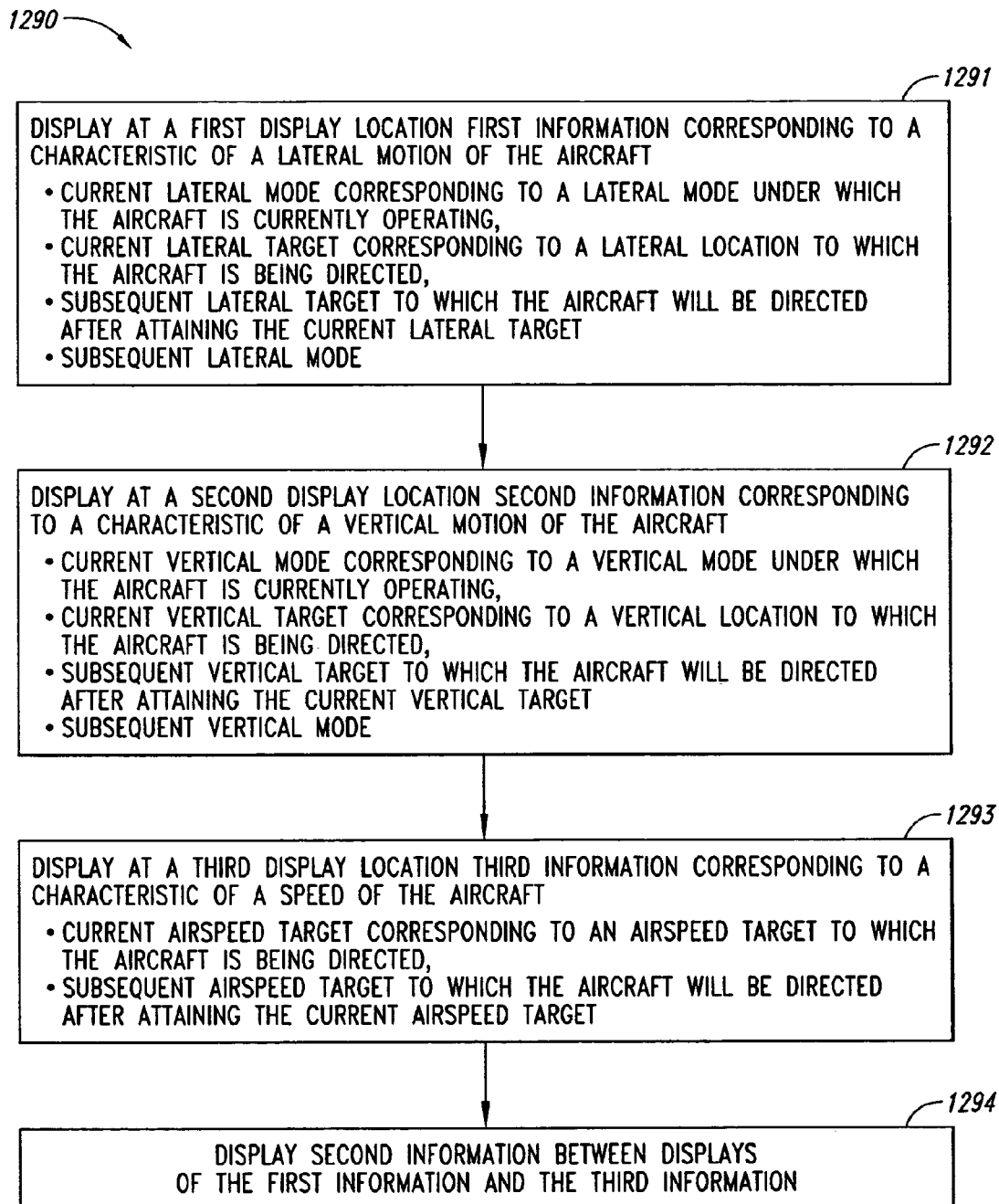

*Fig. 12*

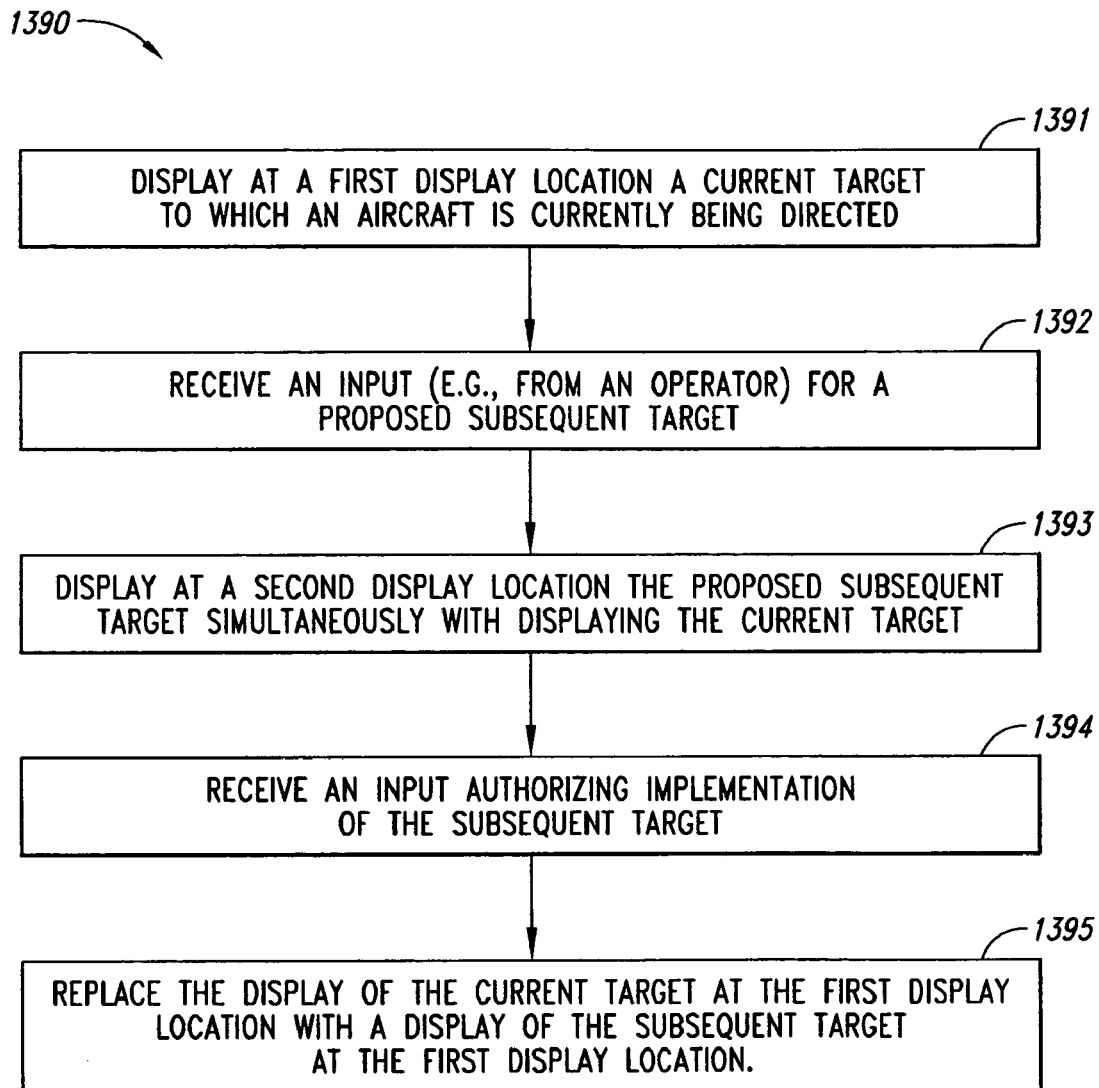

*Fig. 13*

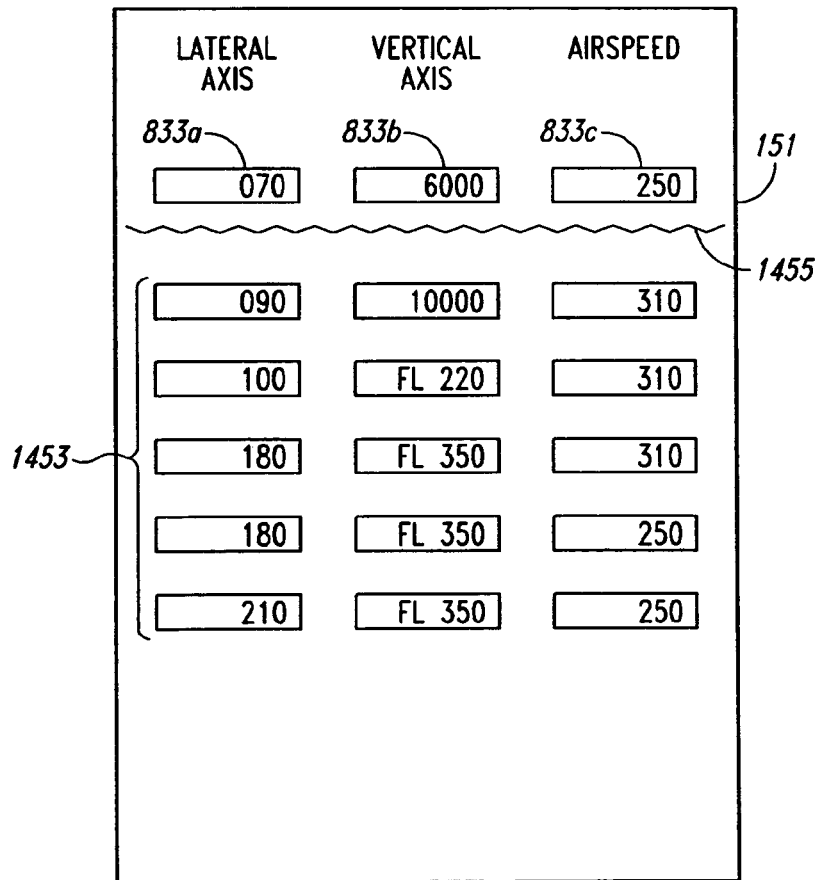
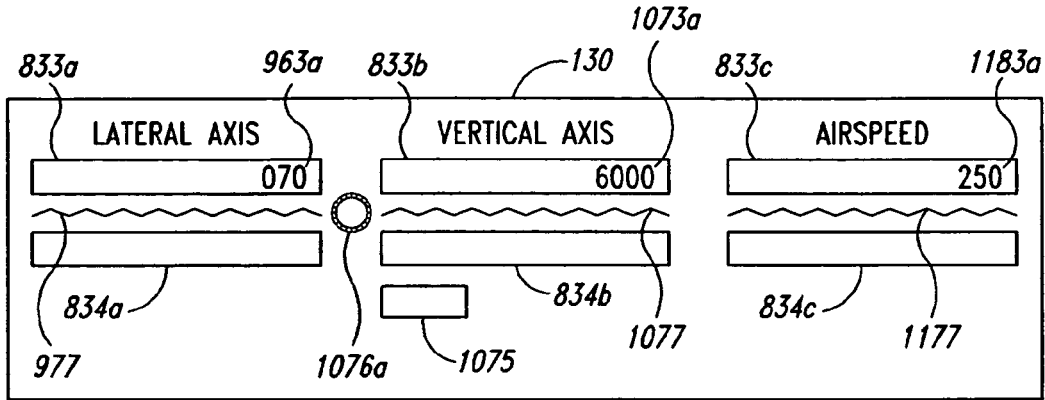

Fig. 14A

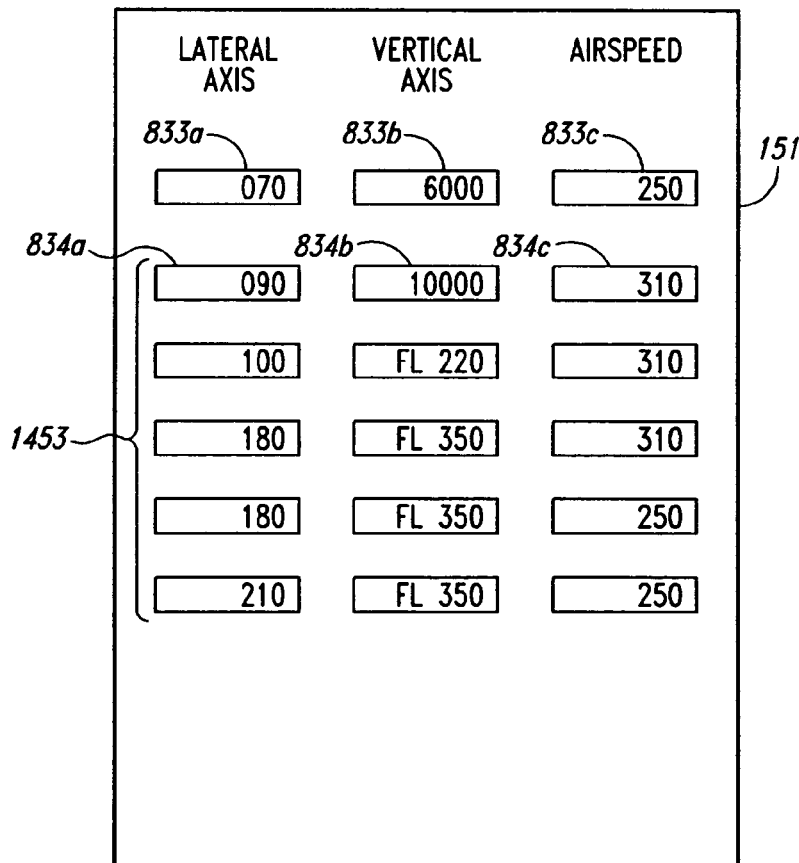
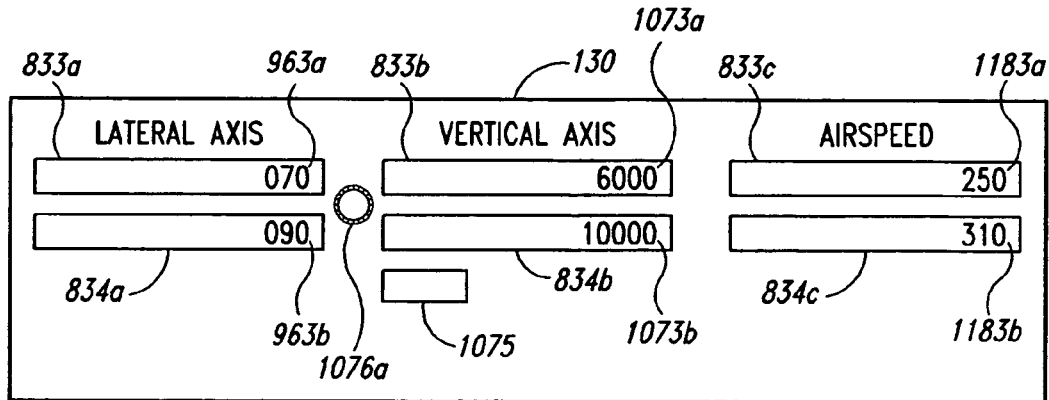

Fig. 14B

# US 7,751,948 B2

Page 2

U.S. PATENT DOCUMENTS							
4,274,096	A	6/1981	Dennison	6,346,892	B1	2/2002	DeMers et al.
4,325,123	A	4/1982	Graham	6,362,750	B1	3/2002	Castor
4,424,038	A	1/1984	Tingleff et al.	6,381,519	B1	4/2002	Snyder
4,471,439	A	9/1984	Robbins et al.	6,381,538	B1	4/2002	Robinson et al.
H000139	H	10/1986	Task	6,389,333	B1	5/2002	Hansman
4,631,678	A	12/1986	Angermuller et al.	6,405,975	B1	6/2002	Sankrithi et al.
4,642,775	A	2/1987	Cline	6,424,909	B2	7/2002	Kusano et al.
4,729,102	A	3/1988	Miller, Jr. et al.	6,443,399	B1	9/2002	Yount et al.
4,792,906	A	12/1988	King	6,449,556	B1	9/2002	Pauly
4,860,007	A	8/1989	Konicke	6,466,235	B1	10/2002	Smith et al.
4,939,661	A	7/1990	Barker et al.	6,470,224	B1	10/2002	Drake et al.
5,050,081	A	9/1991	Abbott	6,473,675	B2	10/2002	Sample
5,070,458	A	12/1991	Gilmore et al.	6,512,527	B1	1/2003	Barber et al.
5,072,218	A	12/1991	Spero et al.	6,522,958	B1	2/2003	Dwyer et al.
5,243,339	A	9/1993	Graham et al.	6,542,796	B1	4/2003	Gibbs et al.
5,289,185	A	2/1994	Ramier et al.	6,556,902	B2	4/2003	Ing
5,329,277	A	7/1994	Dougan et al.	6,606,563	B2	8/2003	Corcoran, III
5,337,982	A	8/1994	Sherry	6,614,419	B1	9/2003	May
5,416,705	A	5/1995	Barnett	6,633,810	B1	10/2003	Qureshi et al.
5,420,582	A	5/1995	Kubbat	6,636,786	B2	10/2003	Partel
5,454,074	A	9/1995	Hartel	6,668,215	B2	12/2003	Lafon et al.
5,475,594	A	12/1995	Oder et al.	6,690,299	B1	2/2004	Suiter
5,499,025	A	3/1996	Middleton et al.	6,693,559	B1	2/2004	Gyde et al.
5,508,928	A	4/1996	Tran	6,696,980	B1	2/2004	Langner et al.
5,519,392	A	5/1996	Oder et al.	6,697,718	B2	2/2004	Le Draoullec et al.
5,523,949	A	6/1996	Agate et al.	6,707,387	B2	3/2004	Noguchi et al.
5,592,198	A	1/1997	Fagard et al.	6,707,475	B1	3/2004	Snyder
5,668,542	A	9/1997	Wright	6,711,475	B2	3/2004	Murphy
5,715,163	A	2/1998	Bang	6,720,891	B2	4/2004	Chen et al.
5,736,955	A	4/1998	Roif	6,721,640	B2	4/2004	Glenn et al.
5,739,769	A	4/1998	Vladimir	6,745,113	B2	6/2004	Griffin, III et al.
5,798,712	A	8/1998	Coquin	6,751,545	B2	6/2004	Walter
5,802,492	A	9/1998	DeLorme et al.	6,753,891	B1	6/2004	Chohan
5,844,503	A	12/1998	Riley et al.	6,784,869	B1	8/2004	Clark et al.
5,875,998	A	3/1999	Gleine	6,812,858	B2	11/2004	Griffin, III
5,884,219	A	3/1999	Curtwright et al.	6,816,780	B2	11/2004	Naimer et al.
5,916,297	A	6/1999	Griffin, III et al.	6,856,864	B1	2/2005	Gibbs et al.
5,940,013	A	8/1999	Vladimir et al.	6,870,490	B2	3/2005	Sherry et al.
5,941,930	A	8/1999	Morimoto et al.	6,871,124	B1	3/2005	McElreath
5,971,318	A	10/1999	Lustre	6,897,790	B2	5/2005	Orton
5,978,715	A	11/1999	Briffe	6,898,492	B2	5/2005	De Leon
5,983,158	A	11/1999	Suzuki et al.	6,909,967	B2	6/2005	Hirano et al.
5,995,290	A	11/1999	Noble	6,915,190	B2	7/2005	Galasso
5,995,901	A	11/1999	Owen et al.	6,934,608	B2	8/2005	Qureshi
6,038,498	A	3/2000	Briffe et al.	6,946,976	B1	9/2005	Langner
6,057,786	A	5/2000	Briffe	6,980,198	B1	12/2005	Gyde et al.
6,067,502	A	5/2000	Hayashida et al.	6,992,596	B2	1/2006	Cole et al.
6,072,473	A	6/2000	Muller et al.	6,992,597	B2	1/2006	Rogers et al.
6,075,467	A	6/2000	Ninagawa et al.	7,030,892	B1	4/2006	Gyde et al.
6,085,129	A	7/2000	Schardt	7,072,746	B1	7/2006	Burch
6,098,014	A	8/2000	Kranz	7,103,455	B2	9/2006	Subelet et al.
6,112,141	A	8/2000	Briffe	7,142,131	B2	11/2006	Sikora
6,118,385	A	9/2000	Leard	7,222,017	B2	5/2007	Clark et al.
6,128,553	A	10/2000	Gordon et al.	7,256,710	B2	8/2007	Mumaw et al.
6,154,151	A	11/2000	McElreath et al.	7,321,318	B2	1/2008	Crane et al.
6,175,315	B1	1/2001	Millard et al.	7,363,119	B2	4/2008	Griffin, III et al.
6,181,987	B1	1/2001	Deker et al.	7,580,235	B2	8/2009	Hamasaki
6,188,937	B1	2/2001	Sherry	2002/0033837	A1	3/2002	Munro
6,199,015	B1	3/2001	Curtwright et al.	2002/0099528	A1	7/2002	Hett
6,246,320	B1	6/2001	Monroe	2003/0025719	A1	2/2003	Palmer et al.
6,246,342	B1	6/2001	Vandevoorde et al.	2003/0036827	A1	2/2003	Murphy
6,262,720	B1	7/2001	Jeffrey	2003/0132860	A1	7/2003	Feyereisen et al.
6,275,172	B1	8/2001	Curtis et al.	2003/0225492	A1	12/2003	Cope et al.
6,278,913	B1	8/2001	Jiang	2004/0006412	A1	1/2004	Doose et al.
6,313,759	B1	11/2001	Musland-Sipper	2004/0059474	A1	3/2004	Boorman et al.
6,314,343	B1*	11/2001	Adams et al. .... 701/3	2005/0090969	A1	4/2005	Siok et al.
6,314,363	B1	11/2001	Pilley et al.	2005/0143871	A1	6/2005	Boorman et al.
6,314,366	B1	11/2001	Farmakis et al.	2005/0178903	A1	8/2005	Boorman et al.
6,314,370	B1	11/2001	Curtright	2005/0182528	A1	8/2005	Dwyer et al.
6,328,265	B1	12/2001	Dizdarevic	2005/0192717	A1	9/2005	Tafs et al.
6,335,694	B1	1/2002	Beksa et al.	2005/0203675	A1	9/2005	Griffin et al.
				2005/0203676	A1	9/2005	Sandell et al.
				2005/0222721	A1	10/2005	Chen et al.

**APPARATUSES AND METHODS FOR  
DISPLAYING AND RECEIVING TACTICAL  
AND STRATEGIC FLIGHT GUIDANCE  
INFORMATION**

CROSS-REFERENCE TO RELATED  
APPLICATION

This application is a divisional of U.S. application Ser. No. 10/746,912, filed on Dec. 24, 2003, which issued on Mar. 6, 2007 as U.S. Pat. No. 7,188,007, and which is incorporated by reference herein its entirety.

TECHNICAL FIELD

The following disclosure relates generally to aircraft flight guidance systems and to apparatuses and methods for displaying and receiving tactical and strategic flight guidance information.

BACKGROUND

Aircraft autoflight systems have evolved over the years from the traditional autopilots for basic flight path control to complex flight management systems capable of automatically flying aircraft over complicated routes without pilot intervention. Such flight management systems typically include an autopilot, an autothrottle, and a flight management computer (FMC) interfaced with the autopilot and autothrottle. Flight decks on aircraft utilizing such systems generally include a number of controls and displays that allow pilots to monitor the flight management system and change autoflight parameters if desired. As flight management systems have evolved, these controls and displays have been positioned in different locations around the flight deck. Over time, these locations have become somewhat standardized within the transport aircraft industry.

FIG. 1A illustrates an aircraft flight deck **20** having a flight management system in accordance with the prior art. The flight deck **20** includes a first pilot seat **24a** and a second pilot seat **24b**, separated by a control pedestal **26**. Forward windows **21** are positioned forward of the seats **24a**, **24b** and provide a forward field of view for the pilots (not shown) seated in the pilot seats **24a**, **24b**. A plurality of flight instruments **27** are positioned on a forward instrument panel **23** and the control pedestal **26** for access by the pilots. A glare shield **22** is positioned below the forward windows **21** to reduce glare on the flight instruments **27**.

The flight instruments **27** can include a number of autoflight controls and displays, including a first control display unit (CDU) **28a** positioned on the control pedestal **26** adjacent to the first pilot seat **24a**, and a second CDU **28b** positioned on the control pedestal **26** adjacent to the second pilot seat **24b**. The first and second CDUs **28a**, **28b** allow the pilots to make data entries into a flight management computer (FMC) for controlling the flight management system. These entries can include flight plan information, e.g., strategic navigation and flight profile parameters. The flight instruments **27** can also include a first primary flight display (PFD) **25a** positioned on the forward instrument panel **23** in front of the first pilot seat **24a**, and a second PFD **25b** positioned on the forward instrument panel **23** in front of the second pilot seat **24b**. The first and second PFDs **24a**, **25b** display actual flight parameters of the aircraft, such as airspeed, altitude, attitude and heading. In addition, the first and second PFDs **25a**, **25b** can also display conventional flight mode annunciators (FMAs). FMAs are textual shorthand codes indicating

the current modes of the autothrottle and autopilot. The flight deck **20** can further include a mode control panel (MCP) **30** incorporated into the glare shield **22**. The MCP **30** provides control input devices for the FMC, autothrottle, autopilot, flight director, and altitude alert systems.

FIG. 1B illustrates a list **90** of existing FMAs corresponding to instructions for automatically controlling the lateral motion and vertical motion of an aircraft, in accordance with the prior art. As shown in FIG. 1B, existing arrangements can include at least nine different lateral modes and at least ten different vertical modes for controlling the motion of the aircraft. Furthermore, the same aircraft flight path control may be annunciated by different FMAs depending on whether the annunciation originates from the MCP **30** or the FMC. Still further, a given FMA may represent very different flight path controls, depending on flight conditions and/or the state of the aircraft's autoflight system.

One characteristic of the foregoing arrangement is that it is relatively complex. A potential drawback with this characteristic is that it can be time consuming and therefore expensive to train flight crews in the use of this system. As a result, the overall cost of operating the aircraft increases, which in turn increases the cost of transporting passengers and goods by air.

SUMMARY

The present invention is directed generally toward methods and apparatuses for controlling aircraft. A computer-implemented method in accordance with one aspect of the invention includes displaying at least one indicator to an operator of an aircraft, with the at least one indicator corresponding to at least one first instruction input by the operator for directing a first aircraft behavior and implemented upon receiving an activation instruction from the operator. The method can further include displaying at least one second indicator to the operator, the at least one second indicator corresponding to at least one second instruction for directing a second aircraft behavior at least approximately the same as the first aircraft behavior. The at least one second instruction is to be automatically implemented at a future time and is at least approximately the same as the at least one first indicator.

The indicators can correspond to maneuvers conducted by the aircraft, with at least generally similar maneuvers having at least approximately the same indicators, whether they are to be implemented imminently or at a future time. The indicators can correspond to lateral motion, vertical motion, or air speed of the aircraft and can be automatically implemented or manually implemented by the operator.

A method in accordance with another aspect of the invention includes presenting a plurality of first level options for controlling an aspect of the aircraft's motion, with at least one of the first level options having associated with it a plurality of second level options. A first input corresponding to a selection of the at least one first level option is received, and the method further includes presenting a plurality of second level options corresponding to the at least one first level option. The method still further includes receiving a second input corresponding to a selection of one of the second level options. The first options can be presented as switch positions of a manual switch having at least two positions, and the second level options can be presented as text messages on a display panel.

BRIEF DESCRIPTION OF THE DRAWINGS

FIG. 1A illustrates a flight deck of an aircraft having a flight management system in accordance with the prior art.

parameter information. The flight instruments **127** can further include a mode control panel (MCP) **130** having input devices **132** for receiving inputs from the operators, and a plurality of displays **131** for providing flight control information to the operators. The inputs received from the operators at the mode control panel **130** are primarily tactical inputs, e.g., inputs that are implemented by the control system immediately upon activation by the operators. A flight management computer (FMC) **150** includes control display units (CDUs) **155a**, **155b** positioned on the control pedestal **126**. The CDUs **155a**, **155b** include a flight plan list display **151** for displaying information corresponding to upcoming segments of the aircraft flight plan. The CDUs **155a**, **155b** also include input devices **152** (e.g., alphanumeric keys) that allow the operators to enter information corresponding to these segments. The inputs received at the flight management computer **150** are primarily strategic inputs, e.g., inputs that are implemented at a later time, for example, upon achieving a flight plan target or completing a previous flight plan segment.

FIG. 3 is a block diagram illustrating generally how components of the flight guidance system **100** interact with each other, in accordance with an embodiment of the invention. In one aspect of this embodiment, the flight guidance computer **110** can receive tactical inputs **190** provided by the operator via the mode control panel **130** or another input device. The flight guidance computer **110** can also receive strategic inputs **191** from the flight management computer **150**, which can in turn receive inputs directly from the operators or from other sources, (e.g., via telemetry) as described above. The flight guidance computer **110** can present current and future strategic information on the flight plan list display **151** (FIG. 2B), as indicated in block **192**. The flight guidance computer **110** can also display the current tactical and/or strategic flight information, together with strategic flight control information for the next upcoming segment of the flight (block **193**) on the mode control panel **130**. In one aspect of this embodiment, the manner in which the information is displayed on the mode control panel **130** and the flight plan list display **151** can be at least approximately identical, as described in greater detail below with reference to FIGS. **14A-14B**.

The flight guidance computer **110** is coupled to the control systems **101a-101c**, each of which can include a corresponding flight control computer **112** (shown as flight control computers **112a-112c**) coupled to one or more corresponding actuators **107** (shown as actuators **107a-107c**). The actuators **107a-107c** provide aerodynamic and thrust outputs to control the lateral motion, vertical motion, and airspeed of the aircraft, as shown in blocks **194a-194c**. Accordingly, the flight guidance computer **110** can (a) receive inputs from a plurality of sources, (b) display information to the operators, and (c) coordinate the delivery of the inputs to the appropriate control devices.

FIG. 4 is a block diagram illustrating a process **490** for displaying tactical and strategic flight control information in a similar or identical manner. The process **490** includes displaying a first indicator to an operator of an aircraft, with the first indicator corresponding to a first instruction input by the operator for controlling a first aircraft behavior (process portion **491**). For example, the first indicator can include alphanumeric symbols representing instructions for controlling the lateral motion, vertical motion and/or airspeed of the aircraft. The first instruction is implemented upon receiving an activation instruction from the operator. For example, the first instruction can be implemented when the operator pushes a switch on the mode control panel **130** (FIG. 3). This type of operation is sometimes referred to herein as “unlinked” operation because the aircraft is responding to tactical

instructions that are typically not tied directly to a predetermined flight plan for the aircraft.

In process portion **492**, a second indicator is displayed to the operator, with the second indicator corresponding to a second instruction for controlling a second aircraft behavior at least approximately the same as the first. The second instruction is to be implemented at a future time. For example, both the first and second behaviors can correspond to an aircraft climb, descend, turn, or other behavior command. The second instruction can include a strategic input received from the flight management computer **150** (FIG. 2B). The second instruction can correspond to a segment of the aircraft flight plan that has not yet been executed, but that will be executed automatically when the segment currently being flown by the aircraft is completed, or upon achieving another target. This type of operation is sometimes referred to herein as “linked” operation because the aircraft is responding to strategic instructions that form part of a predetermined flight plan.

As shown in block **492**, the first indicator is at least approximately the same as the second indicator. Accordingly, when the operator views an indication of the manner in which the aircraft is or will be controlled, that indication is consistent whether the indication is for a tactical instruction input by the operator for immediate (or nearly immediate) implementation, or a strategic instruction to be implemented by the flight guidance system in accordance with a preset flight plan.

In process portion **493**, the first instruction is implemented, and in process portion **494**, the second instruction is implemented. The instructions can be implemented by passing the instructions from the flight guidance computer **110** (FIG. 3) to the flight control computers **112a-112c** (FIG. 3), as described above. In some cases, the instructions provided to control aircraft motion in any axis are independent of the instructions provided to control motion in any other axis. In other cases, the instructions for motion about different axes can be automatically coupled.

In one aspect of the foregoing embodiments, implementing the instructions can include automatically carrying out the instructions, for example, if the operator has engaged the autopilot or autoflight capabilities of the aircraft. In another embodiment, implementing the instructions can include providing a visual guide (e.g., on the PFDs **125** described above with reference to FIG. 2B) that allows the operator to manually fly the aircraft in accordance with the instructions. Such a guide can include a conventional crosshair target for the lateral and vertical motion of the aircraft, and/or a target thrust indicator for aircraft speed.

The indicators described above with reference to FIG. 4 can include mode and submode indicators (which identify the type of maneuver the aircraft is or will be performing) and a target indicator (which identifies the target to which the maneuver is directed). FIG. 5 illustrates a chart **590** comparing lateral motion mode and submode indicators **591** (in accordance with an embodiment of the invention) with existing lateral mode indicators **591a** (generally similar to those described above with reference to FIG. 1A). Modes are indicated by capital letters and submodes by lower case letters. Certain modes and/or submodes are available only for linked operation or only for unlinked operation (in one embodiment), as indicated by superscripts “1” and “2”, respectively.

One feature of the mode and submode indicators **591** is that they are significantly less numerous than the existing mode indicators **591a**. Accordingly, the operator can provide instructions and understand information in a simplified manner, reducing the amount of training time required to become proficient. Another feature of the mode and submode indica-

tors **591** is that they are the same (e.g., as displayed to the operator and as selected by the operator), whether the aircraft is operating in a linked manner or an unlinked manner. This arrangement can provide for more consistency between linked and unlinked operations, further reducing the time required for the operator to become proficient in handling automatic aircraft functions.

Another feature of the mode and submode indicators **591** is that they are arranged hierarchically. For example, if the operator wishes to execute a left turn (represented by mode “L TURN”) or a right turn (represented by mode “R TURN”), the operator can optionally elect to have the turn constrained (submode “constr”) if flying in a linked manner. In a constrained turn, the bank angle is modulated in accordance with strategic targets to achieve “DME” arcs, curved noise abatement departures, complex curved approaches and other pre-selected maneuvers. When the aircraft is operating in an unlinked manner, the operator can optionally elect to have the turn bank angle limited to a value input by the operator (submode “ba”). This hierarchical organization allows the operator to first select the overall type of maneuver or behavior to be executed, and then select the details. Such an arrangement can be more intuitive for the operator than existing modes, and can accordingly further reduce training time.

Still another feature of the mode and submode indicators **591** is that they can have simple, specific and mnemonically consistent meanings. For example, the “L TURN” and “R TURN” modes describe, simply and mnemonically, left turns and right turns, respectively. The “TRACK” mode includes straight flight tracks (e.g., great circle lines), including capturing and maintaining straight flight tracks. The “HDG” mode maintains a selected heading. Under the “HDG” mode, the path of the aircraft does not account for the effects of wind, while under the “TRACK” mode, wind direction is accounted for.

The “LAND” mode (available only during linked operation, in one embodiment) automatically controls a de-crab maneuver just prior to touchdown, and controls runway centerline tracking after landing. The “LAND” mode (and other modes included in the flight plan for actions prior to and subsequent to actual landing) have associated with them sufficient runway information to allow the aircraft to automatically land on a selected runway and conduct pre-landing lead-in and/or post-landing follow-up operations. These modes also have associated with them instructions for an aircraft go-around in the case of a missed approach. One feature of this arrangement is that the “LAND” mode and other modes can be a part of the preset flight plan loaded into the flight management computer **150**. This is unlike existing auto land features which must be input by the operator at the mode control panel. An advantage of this arrangement is that it can reduce the pilot workload during flight because it can be established prior to flight as part of the flight plan. Another advantage is that the go-around feature can be automatically implemented when the operator activates a go-around switch in the flight deck. If necessary, the flight plan information can be updated during flight, for example, if the aircraft is redirected to an alternate landing site.

FIG. 6 illustrates a chart **690** comparing vertical motion mode and submode indicators **691** with existing mode indicators **691a** generally similar to those described above with reference to FIG. 1B. The vertical motion mode and submode indicators **691** can be (a) fewer in number than the existing mode indicators **691a**, (b) nested in a hierarchical fashion, and (c) consistent for both linked and unlinked operation, in a manner generally similar to that described above with reference to FIG. 5. In particular, modes “CLB” and “DES” con-

trol climb and descent, respectively, of the aircraft. Without selecting a submode, these modes can be used for takeoff climb, go-around, terrain avoidance, wind shear escape, normal climb, unconstrained cruise descents, and emergency descents. If the aircraft is flying in a linked manner, the “constr” submode, which can be used for any climb or descent where thrust is modulated to meet a specific way point target is available via the FMC. Alternatively, the “profile” submode for final approach, tunnel climbs and descents, or drift up (e.g., continuous optimal altitude cruise climb) is available. During unlinked operation, the pilot can select the “vs” or “fpa” submodes to climb or descend with a specific vertical speed or flight path angle, respectively.

The “ALT” mode controls all level flight, including capturing and maintaining a particular altitude. The “LAND” mode, available only for unlinked operation in one embodiment, includes flare, touchdown and de-rotation after touchdown.

As described above, the modes and submodes can be arranged hierarchically to provide a simpler, more intuitive manner for displaying and receiving flight control information. FIG. 7 is a flow diagram illustrating a process **790** for presenting to an operator hierarchically organized options for controlling the flight of an aircraft, in accordance with an embodiment of the invention. Process portion **791** includes presenting a plurality of first level options (e.g., mode indicators) for controlling an aspect of the aircraft’s motion. At least one first level option has associated with it a plurality of second level options (e.g., submodes). The first level options can be displayed in a menu-type format, or by settings on one or more switches, or by other arrangements.

In any of these arrangements, the operator can select from among the first level options. Accordingly, the process **790** further includes receiving a first input corresponding to a selection of one of the first level options (process portion **792**). Once the first input has been received, the process **790** can further include presenting a plurality of second level options (e.g., submode indicators) corresponding to the one first level option selected in process portion **792** (process portion **793**). In one aspect of this embodiment, the second level options for each first level option can be unique. In other embodiments, at least some of the second level options can be shared among first level options. In any of these embodiments, in process portion **794**, a second input corresponding to a selection of one of the second level options is received. The selected first and second level options can then be activated to control an aspect of the aircraft’s motion.

One advantage of the foregoing hierarchical structure is that it can be easier to understand. Accordingly, it may require less time and expense to train operators in its use. Another advantage is that such a structure lends itself to future upgrades. For example, if new submodes are developed at a later date, they can be added to the system with relative ease and without disrupting the organization of the first level modes. A further advantage is that the hierarchical structure of the mode options can be implemented on a mode control panel **130** without requiring changes to existing PFDs **125** (FIG. 2B) or head up displays. Accordingly, the mode control panel **130** and associated modes and submodes can more easily be retrofitted on existing flight decks. A mode control panel **130** configured to present the foregoing modes and receive corresponding inputs is described in greater detail below with reference to FIG. 8.

FIG. 8 is a partially schematic illustration of a mode control panel **130** configured in accordance with an embodiment of the invention. The mode control panel **130** can include a lateral motion portion **860**, a vertical motion portion **870**, an airspeed portion **880**, and a general control portion **845**. The



general control portion **845** can include a performance selector **846** which can be manipulated by the pilot to determine how aggressively the aircraft carries out control inputs. In a particular aspect of this embodiment, each setting of the performance selector **846** establishes performance behavior that is the same or approximately the same for lateral motion, vertical motion and airspeed. An autothrottle switch **848** is used by the pilot to engage the autothrottles, and an autoflight switch **847** is used by the operator to engage the autopilot and autothrottle capabilities of the system **100**.

Each of the remaining portions **860**, **870** and **880** can include displays **831** (shown as a lateral motion display **831a**, a vertical motion display **831b**, and an airspeed display **831c**), and input devices **832** (shown as lateral motion input devices **832a**, vertical motion input devices **832b**, and airspeed input devices **832c**). Each display **831** can include current control indicators **833** (shown as lateral, vertical and airspeed current control indicators **833a**, **833b** and **833c**, respectively) and next control indicators **834** (shown as next lateral, vertical and airspeed control indicators **834a**, **834b** and **834c**, respectively). The current control indicators **833** pertain to the maneuver currently being executed by the aircraft, and the next control indicators pertain to the next maneuver to be executed by the aircraft. In a particular aspect of this embodiment, the manner in which the next indicators are displayed can indicate which aspect of the upcoming maneuver will be executed first. For example, if the next lateral control indicator **834a** identifies an upcoming change in heading, and the next vertical control indicator **834b** identifies an upcoming change in altitude to be implemented after the change in heading, the next lateral control indicator **834a** can appear in a different font or color to indicate that the change in heading will be executed before the change in altitude. If these changes will be executed at the same time, they can be displayed in the same manner. Further details of the current control indicators **833** and next control indicators **834** are provided below with reference to FIGS. 9A-11B.

FIG. 9A illustrates the lateral motion portion **860** of the mode control panel **130** described above with reference to FIG. 8 as it appears during linked operation in accordance with an embodiment of the invention. The current lateral control indicators **833a** are arranged on one line, and the next lateral control indicators **834a** are arranged below. The current lateral control indicators **833a** include a current lateral mode indicator **961a**, a current lateral submode indicator **991a** (shown blank in FIG. 9A), a current lateral link indicator **962a** and a current lateral target indicator **963a**. The next lateral control indicators **834a** include a next lateral mode indicator **961b**, a next lateral submode indicator **991b** (also blank), a next lateral link indicator **962b**, and a next lateral target indicator **963b**.

The lateral current mode and submode indicators **961a**, **991a** indicate the lateral mode under which the aircraft is currently operating, and the current lateral target **963a** indicates the lateral target to which the aircraft is being directed. The current lateral link indicator **962a** indicates that lateral control of the aircraft is linked to the flight plan via the flight management computer **150** (FIG. 2B). The next lateral mode indicator **961b** and submode indicator **991b** indicate the lateral mode and submode under which the aircraft will operate upon attaining the current lateral target **963a**. At that point, the aircraft will be controlled to the next lateral target **963b**. The next lateral link indicator **962b** indicates that this operation will also be linked to the flight plan. The operator can link the operation of the aircraft to the flight plan by pressing a link switch **966a**, which, if the aircraft is not already operating in

a linked manner, will cause the aircraft to fly to the next available segment programmed into the flight management computer **150**.

During linked operation, the modes, submodes and targets displayed in the lateral motion display **831a** are obtained directly from the flight management computer **150**. During unlinked operation, the modes and submodes can be selected by the operator when the operator actuates switches at the mode control panel **130**. For example, the operator can toggle between the "HDG" or "TRK" modes by toggling a lateral maintain selector switch **966b**. The selected and available modes appear in an adjacent lateral maintain display **964** with the selected mode highlighted (e.g., by appearing in a larger font) as shown in FIG. 9A. The color of the mode (or submode) indicator can identify to the operator (a) whether the mode (or submode) is available to be selected, and/or (b) whether operation of the mode (or submode) is linked or unlinked. The operator can select a bank angle submode using a bank limit selector switch **966c**. The selected and available bank limit submodes appear in a bank limit display **965**. The operator can actuate a lateral selector **966f** to indicate the direction and target for left and right turns, and can activate a lateral hold switch **966e** to roll the aircraft out of a current turn. If the aircraft is in linked operation, pushing the lateral selector **966f** or lateral hold switch **966e** will automatically unlink the lateral motion of the aircraft from the flight management computer **150**.

In one aspect of the foregoing arrangement, the current lateral target **963a** can be automatically updated when the operator activates the lateral hold switch **966e**. For example, the current lateral target **963a** can be updated immediately (or nearly immediately) after the lateral hold switch **966e** has been activated to provide an estimate of the new lateral target to which the aircraft will be directed upon completion of the rollout maneuver. In another aspect of this embodiment, which can be implemented in addition to or in lieu of the foregoing aspect, the current lateral target **963a** can be updated once the rollout maneuver has been completed to indicate the actual new target to which the aircraft is being directed.

FIG. 9B illustrates the lateral motion display **831a** during unlinked operation, in accordance with an embodiment of the invention. An unlink indicator **977** highlights to the operator that the current operation is unlinked, and the current lateral control indicators **833a** indicate the current lateral mode **961a** and current lateral target **963a**. A link prompt **967a** indicates that the pilot can link to the flight plan by pressing the link switch **966a**. In one embodiment, if the distance to the flight plan route is less than 2.5 nautical miles, the aircraft will fly in mode "L TURN," "R TURN," "HDG" or "TRK" to get to the flight plan route. If the distance is greater than 2.5 miles, the flight guidance computer **110** (FIG. 3) creates a new leg and intercept way point and automatically links the leg with the route.

In another embodiment, the lateral motion display **831a** can also include next lateral control indicators **834a** (shown blank in FIG. 9B) identifying the next available segment in the flight plan. Accordingly, the operator can easily see which instruction will be implemented if he or she chooses to convert from unlinked operation to linked operation by pressing the link switch **966a**.

During unlinked operation, the operator can set up a right or left turn by rotating the lateral selector **966f** to the right or left, respectively. As the operator rotates the lateral selector **966f**, a preview display **969** indicates the sense of the turn (e.g., left or right), the target to which the turn will be directed, and whether upon completion of the turn the aircraft will be in

“HDG” mode or “TRK” mode. In a particular aspect of this embodiment, the sense of the turn will remain the same as long as the operator keeps rotating the lateral selector **966f** in the same direction, even if the operator rotates beyond a value that is 180° from the current target. That is, if the operator inputs a 270° left turn by rotating the lateral selector **966f** to the left, the aircraft will (upon activation of the instruction) turn 270° to the left, not 90° to the right. This arrangement can accordingly be more intuitive for the operator than some existing systems for which the sense of the turn can depend on the extent of the turn. The pilot can pull the lateral selector **966f** to blank the lateral preview display **969**, and can push the lateral selector **966f** to (a) unlink the lateral motion of the aircraft, if it is not already unlinked, (b) activate the instruction in the lateral preview window **969** (causing this information to appear at the current control indicator display **833a**), and (c) blank the lateral preview display **969**.

The lateral selector **966f** can be configured to be easily accessible and identifiable to the operator. For example, the lateral selector **966f** can include a flange **995** having a compass-like rosette, which signifies the lateral aspect of the motion it controls and distinguishes it from other switches on the mode control panel **130**. The flange **995** can project below a lower edge **935** of the mode control panel **130**, allowing the operator to easily rotate the lateral selector **966f** by engaging the flange with a single finger. Alternatively, the operator can rotate the lateral selector **966f** by grasping an outwardly extending knob **996**.

FIG. **10A** illustrates the vertical motion portion **870** of the mode control panel **130** during linked operation in accordance with an embodiment of the invention. The overall layout of the vertical motion display **831b** and the operation of its input devices are generally similar to those described above with reference to the lateral motion portion **860**. Accordingly, the vertical motion display **831b** can include a current vertical control indicator **833b** and a next vertical control indicator **834b** positioned just below. The current vertical control indicator **833b** can include a current vertical mode indicator **1071a**, a current vertical submode indicator **1091a**, a current vertical link indicator **1072a**, and a current vertical target **1073a**. The next vertical control indicator **834b** can include a next vertical mode indicator **1071b**, a next vertical submode indicator **1091b** (blank in FIG. **10A**), a next vertical link indicator **1072b**, and a next vertical target **1073b**.

If the vertical motion of the aircraft is not already linked to the flight management computer, the operator can create the link by pressing the link switch **1076a**. The operator can also rotate the link switch **1076a** to select a new target altitude, which appears in a limit altitude display **1075**. The limit altitude is inserted into the flight plan. Pulling the link switch **1076a** blanks the limit altitude display **1075**. Further details of this feature are described below with reference to FIGS. **14A-14B**.

FIG. **10B** illustrates the vertical motion portion **870** of the mode control panel **130** during unlinked operation. During unlinked operation, an unlink indicator **1077** appears below the current vertical control indicator **833b**, and a link prompt **1067a** appears adjacent to the link switch **1076a**. The operator can select modes and submodes using the switches at the vertical motion portion **870** of the mode panel **130**, in a manner generally similar to that described above with reference to the lateral motion portion **860**. For example, the operator can toggle between controlling the aircraft’s vertical motion by vertical speed or flight path angle by toggling a vertical maintain selector switch **1076b** and changing a corresponding display in a vertical maintain display **1074**. The operator can set the value of the vertical speed or flight path

angle by rotating a rotary switch **1076c**. The operator can engage the “vs” or “fpa” submodes by pressing an engage switch **1076d**.

The operator can control the altitude target to which the aircraft will be directed with a vertical selector **1076e**. The operator can rotate an altitude selector **1076f** and can adjust an increment selector **1076g** to control whether the value generated by the altitude selector **1076f** is in thousands of feet or hundreds of feet. As the operator adjusts the vertical selector **1076e**, the mode and target are updated in a vertical preview display **1079**. When the operator pushes the vertical selector **1076e**, the vertical motion axis of the aircraft is unlinked (if it is not already unlinked), the information in the vertical preview display **1079** is presented in the current vertical indicator **833b**, and the vertical preview display **879** is blanked. Pressing a vertical hold switch **1076h** will cause the aircraft to level out and maintain the resulting altitude. The current vertical target **1073a** can be updated to provide an estimated and/or actual level out altitude, in a manner generally similar to that described above with reference to the current lateral target **963a** shown in FIGS. **9A-9B**. If the operator presses a drift down switch **1076i**, the aircraft will fly as gradual a descent as possible, for example, during engine-out operation. In a particular aspect of this embodiment, the gradual descent can be automatically implemented based solely upon the input received when the operator presses the drift down switch **1076i**. This is unlike some existing systems which require the operator to change the corresponding cruise altitude and activate an engine-out mode of the flight management computer **150** (FIG. **3**) before actually implementing the drift down procedure. Accordingly, the foregoing, simplified arrangement can reduce pilot workload, errors and/or training time and can allow the drift down feature to be more quickly activated.

FIG. **11A** illustrates the airspeed portion **880** of the mode control panel **130**, displaying flight control information during linked operation, in accordance with an embodiment of the invention. Several aspects of the airspeed portion **880** are generally similar to the lateral motion portion **860** and the vertical motion portion **870** described above. For example, the airspeed display **831b** can include a current airspeed indicator **833c** and a next airspeed indicator **834c** positioned below. The operator can push an airspeed link switch **1186a** to link the commanded airspeed target (e.g., via the aircraft engines and/or elevators) to the flight plan, as reflected by the current link indicator **1182a** and next link indicator **1182b**.

In a particular aspect of this embodiment, the automatic control of the aircraft’s airspeed is not characterized by modes, but rather by targets along with information indicating the basis for the targets. For example, the current airspeed control indicator **833c** can include a current target **1183a** and the next airspeed indicator **834c** can include a next target **1183b**. Each of the targets **1183a**, **1183b** can include a numerical value of the airspeed to which the aircraft is being controlled and a textual indicator of the basis for the airspeed. For example, “Restr” can indicate a flight plan speed restriction, “Econ” can indicate an economy airspeed setting, “Flap Lim” can indicate a limit speed corresponding to a currently extended flap position, and “Flap Ref” can indicate a maneuvering speed corresponding to a currently extended flap position.

The airspeed display **831c** can also include an energy management display **1184**, which indicates the manner in which the longitudinal motion and vertical motion of the aircraft are controlled, which in turn depends upon the mode selected for the vertical motion of the aircraft. In one aspect of this embodiment, the energy management display **1184** can

include a first indicator **1184a** for a first aircraft control force in a first direction (e.g., “Pitch”) and a second indicator **1184b** for a second aircraft control force in a second direction (e.g., “Thrust” or “Drag”). The energy management display **1184** also includes a longitudinal target **1184c** (e.g., “Spd” for speed) and a vertical target **1184d** (e.g., “Clb” for climb, “Des” for descent, or “Alt” for fixed altitude). A first (pitch) control link **1184f** (e.g., a line with an arrowhead) indicates whether the pitch attitude of the aircraft is being used to control to a longitudinal target or a vertical target. A second (thrust/drag) control link **1184e** indicates whether the thrust devices (e.g., engines) or drag devices (e.g., speedbrakes) are being used to control the aircraft to a longitudinal target or a vertical target. For example, when the aircraft is climbing, the first (pitch) control link **1184f** indicates that the pitch of the aircraft is being adjusted to maintain a target airspeed. The second (thrust/drag) control link **1184e** indicates that the thrust of the aircraft is being controlled to maintain a target climb rate. The positions of the control links **1184f** and **1184e** can be changed depending upon the manner in which these parameters are controlled, as described below with reference to FIG. 11B.

FIG. 11B illustrates the airspeed control portion **880** during unlinked operation in accordance with an embodiment of the invention. In one aspect of this embodiment, an unlink indicator **1177** highlights the fact that the aircraft is operating in an unlinked manner. During unlinked operation, the operator can select a target airspeed by adjusting an airspeed knob **1186d**, and can determine whether the airspeed is identified by Mach number or indicated airspeed (IAS) by manipulating a toggle switch **1186b**. The operator can also select among a variety of airspeeds (with associated text modifiers) by pressing an airspeed options key **1186c**. By repeatedly pressing the airspeed options key **1186c**, the operator can scroll through a list of airspeed options, each of which corresponds automatically to a particular airspeed. These options can include “E/O” (engine out), “LRC” (long range cruise), “Co” (company specified speed), “Vx” (best flight path angle), “Vy” (best rate of climb), “Trb” (turbulent air penetration), and “Gld” (best glide speed). The value selected by manipulating the airspeed options key **1186c** or the airspeed selector **1186d** can appear in an airspeed preview display **1189**. Pushing the airspeed selector **1186d** activates the instruction in the airspeed preview display **1189** and updates the current airspeed control indicator **833c** accordingly.

In one aspect of the foregoing embodiments, some or all of the indicators can be textual indicators, graphical indicators or a combination of textual and graphical indicators. The links **1184e**, **1184f** can change color or another characteristic when it is possible for the operator to change which target **1184c**, **1184d** is coupled to the first and second indicators **1184a**, **1184b**. In other embodiments, other indicators can also be displayed in different manners depending on whether or not the corresponding control option is available to the operator. For example, in one further embodiment, modes and/or submodes can be displayed in one manner if they are consistent with the selected target, and in another manner if they are inconsistent with the selected target. In a further aspect of this embodiment, the modes and/or submodes that are inconsistent with the selected target may be unavailable for selection by the operator. For example, if the operator chooses a target located above the aircraft’s current altitude, the “DES” mode will appear differently to the operator and/or will be unavailable for selection by the operator.

One feature of an embodiment of the mode control panel **130** described above with reference to FIGS. 8-11B is that the arrangement and operation of many of the controls and dis-

plays are consistent across at least two of the motion axes. For example, if the operator wishes to link operation of any of the motion axes (which can be done independently of linking the remaining axes), the operator presses a switch located toward the top of the mode control panel **130**. If the operator wishes to unlink operation of any of the axes (which can be done independently of unlinking the remaining axes), the operator presses a switch located toward the bottom of the mode control panel **130**. The target to which the aircraft is currently being directed is consistently positioned above the target to which the aircraft will subsequently be directed. For motion axes having modes and submodes, the modes are consistently positioned to the left of the target and to the left of the link indicator. Each axis can include a preview display indicating the parameters to which the aircraft will be controlled during unlinked operation, before the pilot actually initiates such unlinked operations. An advantage of the foregoing arrangement is that the controls for all three axes can be more intuitive and can accordingly reduce the time required by the pilot to become proficient in the use of the controls.

Another feature of an embodiment of the mode control panel **130** described above is that the current targets to which the aircraft is flying can be displayed in a continuous manner, simultaneously with displaying current mode information. An advantage of this feature is that the operator can consistently locate current target information at the same location within the flight deck. Accordingly, the operator’s workload can be reduced.

Still another feature of an embodiment of the mode control panel **130** described above is that the lateral motion, vertical motion, and airspeed of the aircraft are displayed sequentially (e.g., from left to right). An advantage of this arrangement is that this ordering is consistent with the order in which instructions are conventionally relayed to the operator by air traffic control (ATC). Accordingly, the operator can easily view and/or modify the control information while receiving instructions from air traffic control, without having to visually skip over various portions of the mode control panel **130**. Instead, the operator can move his or her eyes and/or hand in a serial fashion from one display portion to the next as the instructions are received.

FIG. 12 illustrates a process corresponding to the manner of operation described just above. The process **1290** can include displaying at a first display location first information corresponding to a characteristic of a lateral motion of the aircraft (process portion **1291**), displaying at a second display location second information corresponding to a characteristic of a vertical motion of the aircraft (process portion **1292**), and displaying at a third display location third information corresponding to a characteristic of a speed of the aircraft (process portion **1293**). The second information can be displayed between the displays of the first information and the third information (process portion **1294**). In a particular aspect of this embodiment, displaying the first information (process portion **1291**) can include displaying a lateral mode under which the aircraft is currently operating, displaying a lateral target corresponding to the lateral location to which the aircraft is automatically being directed, displaying a subsequent lateral target to which the aircraft will be automatically directed after attaining the current lateral target, and (in a particular embodiment) displaying a subsequent lateral mode. In a generally similar manner, displaying the second information can include displaying current vertical mode information, current vertical target information, and subsequent vertical target information (and/or mode), and displaying the third information can include displaying the current airspeed target and subsequent airspeed target.

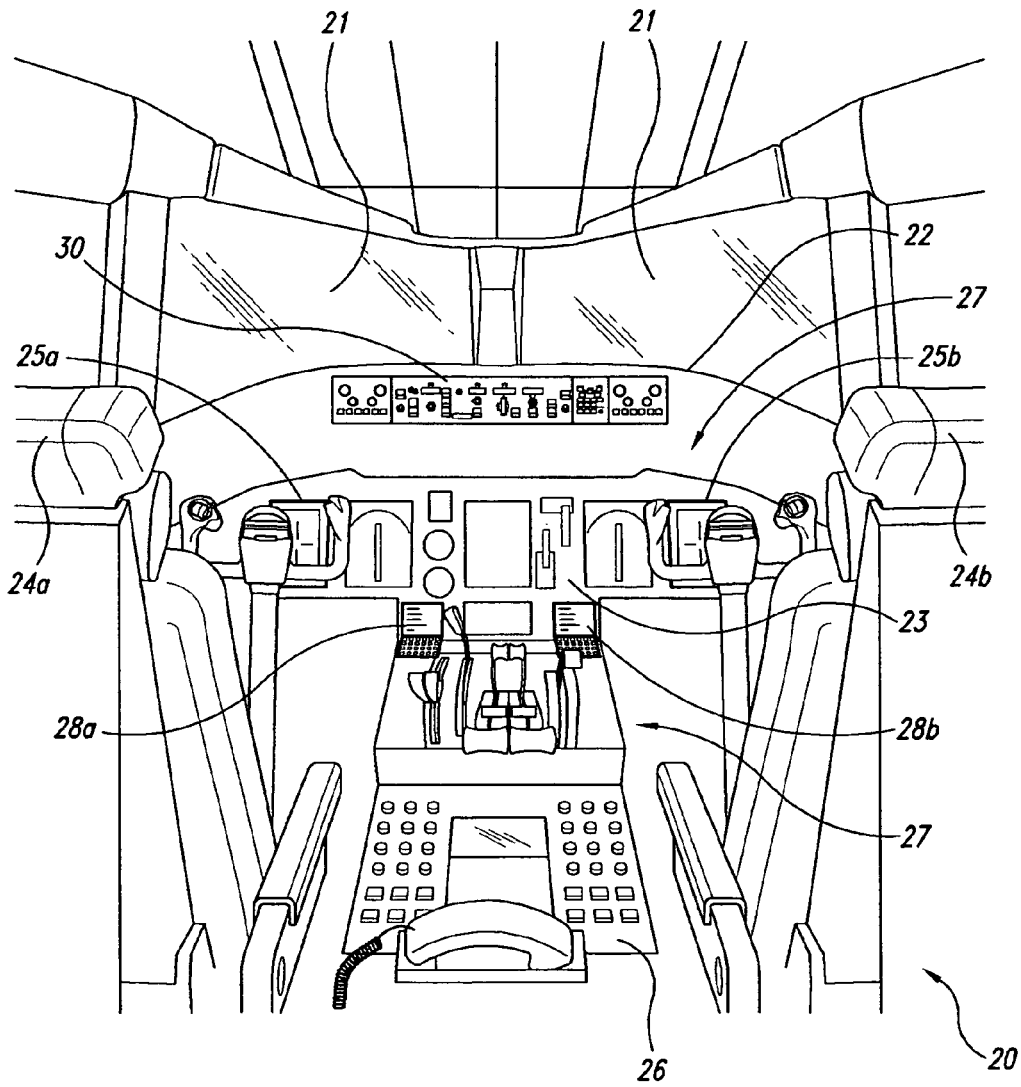

*Fig. 1A*  
*(Prior Art)*