



US010070627B2

(12) **United States Patent**  
**Tupin, Jr. et al.**

(10) **Patent No.:** **US 10,070,627 B2**  
(45) **Date of Patent:** **\*Sep. 11, 2018**

(54) **ANIMAL HEALTH AND WELLNESS  
MONITORING USING UWB RADAR**

(71) Applicant: **i4c Innovations Inc.**, Chantilly, CA  
(US)

(72) Inventors: **Joe Paul Tupin, Jr.**, Round Hill, VA  
(US); **John Michael Couse**, Toronto  
(CA)

(73) Assignee: **i4C Innovations Inc.**, Chantilly, VA  
(US)

(\* ) Notice: Subject to any disclaimer, the term of this  
patent is extended or adjusted under 35  
U.S.C. 154(b) by 15 days.

This patent is subject to a terminal dis-  
claimer.

(21) Appl. No.: **15/377,281**

(22) Filed: **Dec. 13, 2016**

(65) **Prior Publication Data**

US 2017/0181409 A1 Jun. 29, 2017

**Related U.S. Application Data**

(63) Continuation of application No. 14/086,721, filed on  
Nov. 21, 2013, now Pat. No. 9,526,437.

(Continued)

(51) **Int. Cl.**

**A01K 29/00** (2006.01)

**A61B 5/05** (2006.01)

(Continued)

(52) **U.S. Cl.**

CPC ..... **A01K 29/005** (2013.01); **A01K 27/009**  
(2013.01); **A61B 5/0205** (2013.01);

(Continued)

(58) **Field of Classification Search**

CPC .... A01K 29/00; A01K 27/001; A01K 27/009;  
A61B 5/0205; A61B 5/1102; A61B  
5/6802; A61B 5/6831; A61B 5/681; A61B  
5/6801; A61B 5/0507; A61B 5/6822;  
A61B 5/02438; A61B 5/0816; A61B  
2503/40

(Continued)

(56) **References Cited**

U.S. PATENT DOCUMENTS

4,527,240 A 7/1985 Kvitash  
4,930,519 A 6/1990 Anderson et al.  
(Continued)

FOREIGN PATENT DOCUMENTS

CA 1296068 C 2/1992  
CA 2 485 129 A1 5/2005  
(Continued)

OTHER PUBLICATIONS

Jun. 1, 2017 (CN) Office Action—App. 201480063728.7.

(Continued)

*Primary Examiner* — Trinh T Nguyen

(74) *Attorney, Agent, or Firm* — Banner & Witcoff, Ltd.

(57) **ABSTRACT**

A collar with an ultra-wideband radar is described. A hous-  
ing contains sensor electronics and the transmit and receive  
antennas are located separate from the housing around the  
circumference of the collar. A first example of the collar  
includes a first transmit antenna and a first receive antenna.  
A second example of the collar adds a second transmit  
antenna and a second receive antenna.

**20 Claims, 12 Drawing Sheets**

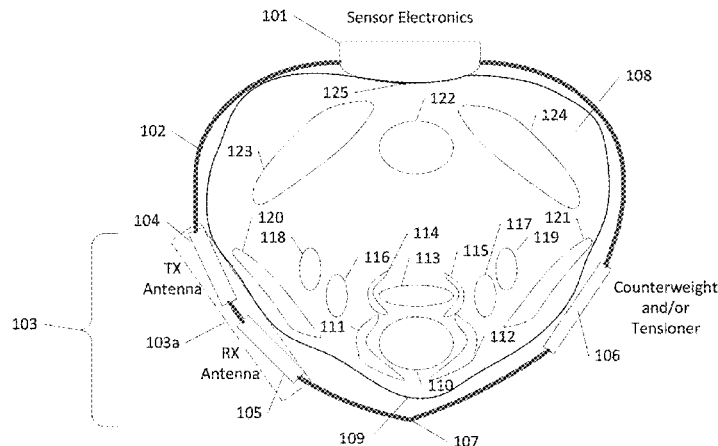

**Related U.S. Application Data**

(60) Provisional application No. 61/729,298, filed on Nov. 21, 2012.

(51) **Int. Cl.**

*A61B 5/0205* (2006.01)  
*A01K 27/00* (2006.01)  
*A61B 5/00* (2006.01)  
*A61B 5/024* (2006.01)  
*A61B 5/08* (2006.01)  
*G01S 13/88* (2006.01)  
*A61B 5/11* (2006.01)  
*G01S 13/02* (2006.01)

(52) **U.S. Cl.**

CPC ..... *A61B 5/02438* (2013.01); *A61B 5/0507* (2013.01); *A61B 5/0816* (2013.01); *A61B 5/1107* (2013.01); *A61B 5/6822* (2013.01); *A61B 5/6831* (2013.01); *G01S 13/0209* (2013.01); *G01S 13/88* (2013.01); *A61B 2503/40* (2013.01)

(58) **Field of Classification Search**

USPC ..... 119/859, 856, 857, 858, 863, 865; 600/484, 300, 301, 529, 481, 483  
 See application file for complete search history.

(56) **References Cited**

U.S. PATENT DOCUMENTS

5,037,305 A 8/1991 Aleck  
 5,289,163 A 2/1994 Perez et al.  
 5,389,934 A 2/1995 Kass  
 5,461,365 A 10/1995 Schlager et al.  
 5,650,770 A 7/1997 Schlager et al.  
 5,772,585 A 6/1998 Lavin et al.  
 6,193,654 B1 2/2001 Richardson et al.  
 6,198,390 B1 3/2001 Schlager et al.  
 6,238,354 B1 5/2001 Alvarez  
 6,366,871 B1 4/2002 Geva  
 6,402,692 B1 6/2002 Morford  
 6,497,656 B1 12/2002 Evans et al.  
 6,518,889 B2 2/2003 Schlager et al.  
 6,616,607 B2 9/2003 Hashimoto et al.  
 6,693,585 B1 2/2004 MacLeod  
 6,697,103 B1 2/2004 Fernandez et al.  
 6,723,055 B2 4/2004 Hoffman  
 6,730,023 B1 5/2004 Dodds  
 6,733,464 B2 5/2004 Olbrich et al.  
 6,811,113 B1 11/2004 Silansky et al.  
 6,847,892 B2 1/2005 Zhou et al.  
 6,889,135 B2 5/2005 Curatolo et al.  
 6,893,396 B2 5/2005 Schulze et al.  
 6,910,050 B2 6/2005 Pawlick  
 6,941,239 B2 9/2005 Unuma et al.  
 6,988,026 B2 1/2006 Breed et al.  
 7,020,508 B2 3/2006 Stivoric et al.  
 7,089,099 B2 8/2006 Shostak et al.  
 7,154,398 B2 12/2006 Chen et al.  
 7,187,960 B2 3/2007 Abreu  
 7,196,628 B2 3/2007 Hixson  
 7,218,242 B2 5/2007 Scalisi et al.  
 7,261,690 B2 8/2007 Teller et al.  
 7,265,666 B2 9/2007 Daniel  
 7,282,028 B2 10/2007 Kim et al.  
 7,285,090 B2 10/2007 Stivoric et al.  
 7,297,110 B2 11/2007 Goyal et al.  
 7,299,159 B2 11/2007 Nanikashvili  
 7,330,784 B2 2/2008 Johnson et al.  
 7,335,168 B2 2/2008 Rugg  
 7,371,214 B2 5/2008 Kouchi et al.  
 7,380,518 B2 6/2008 Kates  
 7,396,331 B2 7/2008 Mack et al.  
 7,399,220 B2 7/2008 Kriesel et al.

7,399,277 B2 7/2008 Saidara et al.  
 7,423,526 B2 9/2008 Despotis  
 7,427,920 B2 9/2008 Martin et al.  
 7,467,034 B2 12/2008 Breed et al.  
 7,467,809 B2 12/2008 Breed et al.  
 7,482,935 B2 1/2009 Lee  
 7,492,251 B1 2/2009 Katz  
 7,527,288 B2 5/2009 Breed  
 7,539,532 B2 5/2009 Tran  
 7,539,533 B2 5/2009 Tran  
 7,558,622 B2 7/2009 Tran  
 7,589,638 B2 9/2009 Jackson et al.  
 7,610,094 B2 10/2009 Stahmann et al.  
 7,616,110 B2 11/2009 Crump et al.  
 7,650,210 B2 1/2010 Breed  
 7,659,826 B2 2/2010 Humbard  
 7,675,410 B2 3/2010 Aritsuka et al.  
 7,679,504 B2 3/2010 Wang et al.  
 7,689,437 B1 3/2010 Teller et al.  
 7,691,068 B2 4/2010 Felder et al.  
 7,705,736 B1 4/2010 Kedziora  
 7,712,365 B1 5/2010 James  
 7,728,724 B1 6/2010 Scalisi et al.  
 7,734,061 B2 6/2010 Breed et al.  
 7,761,312 B2 7/2010 Brown  
 7,785,257 B2 8/2010 Mack et al.  
 7,800,506 B2 9/2010 Zehavi  
 7,826,983 B2 11/2010 Alwan et al.  
 7,830,962 B1 11/2010 Fernandez et al.  
 7,843,350 B2 11/2010 Geissler et al.  
 7,857,771 B2 12/2010 Alwan et al.  
 7,860,731 B2 12/2010 Jackson et al.  
 7,867,141 B2 1/2011 Matsumura et al.  
 7,889,069 B2 2/2011 Fifolt et al.  
 7,905,832 B1 3/2011 Lau et al.  
 7,949,405 B2 5/2011 Feher  
 7,999,741 B2 8/2011 Graves et al.  
 8,015,026 B2 9/2011 Schweisguth et al.  
 8,019,501 B2 9/2011 Breed  
 8,019,633 B2 9/2011 Stroman et al.  
 8,033,996 B2 10/2011 Behar  
 8,036,851 B2 10/2011 Vock et al.  
 8,060,109 B2 11/2011 Fomukong et al.  
 8,073,707 B2 12/2011 Teller et al.  
 8,094,009 B2 1/2012 Allen et al.  
 8,102,256 B2 1/2012 Scalisi et al.  
 8,103,333 B2 1/2012 Tran  
 8,121,673 B2 2/2012 Tran  
 8,125,331 B2 2/2012 Allen et al.  
 8,125,332 B2 2/2012 Curran et al.  
 8,157,730 B2 4/2012 LeBoeuf et al.  
 8,170,609 B2 5/2012 Hedtke et al.  
 8,172,777 B2 5/2012 Goto  
 8,195,188 B2 6/2012 Fomukong et al.  
 8,204,786 B2 6/2012 LeBoeuf et al.  
 8,214,007 B2 7/2012 Baker et al.  
 8,224,355 B2 7/2012 Beydler et al.  
 8,248,231 B2 8/2012 Taylor  
 8,255,238 B2 8/2012 Powell et al.  
 8,271,015 B2 9/2012 Aoki et al.  
 8,284,046 B2 10/2012 Allen et al.  
 8,297,231 B2 10/2012 Yanai et al.  
 8,305,220 B2 11/2012 Gibson  
 8,308,641 B2 11/2012 Moroney, III et al.  
 8,323,188 B2 12/2012 Tran  
 8,328,718 B2 12/2012 Tran  
 2001/0044588 A1 11/2001 Mault  
 2001/0049471 A1 12/2001 Suzuki et al.  
 2002/0010390 A1 1/2002 Guice et al.  
 2002/0019584 A1 2/2002 Schulze et al.  
 2002/0021219 A1 2/2002 Edwards  
 2002/0115915 A1 8/2002 Pratt et al.  
 2002/0143241 A1 10/2002 Thorell  
 2002/0154015 A1 10/2002 Hixson  
 2003/0004403 A1 1/2003 Drinan et al.  
 2003/0139655 A1 7/2003 Dodds  
 2003/0166996 A1 9/2003 Kim et al.  
 2003/0210147 A1 11/2003 Humbard  
 2004/0027246 A1 2/2004 Aguglia

(56)

References Cited

U.S. PATENT DOCUMENTS

2004/0061606 A1 4/2004 Gronvold  
 2004/0100376 A1 5/2004 Lye et al.  
 2004/0130446 A1 7/2004 Chen et al.  
 2004/0148140 A1 7/2004 Tarassenko et al.  
 2005/0090718 A1 4/2005 Dodds  
 2005/0099294 A1 5/2005 Bogner et al.  
 2005/0101843 A1 5/2005 Quinn et al.  
 2005/0124864 A1 6/2005 Mack et al.  
 2005/0134452 A1 6/2005 Smith  
 2005/0197546 A1 9/2005 Mardiks et al.  
 2005/0234310 A1 10/2005 Alwan et al.  
 2006/0006999 A1 1/2006 Walczyk et al.  
 2006/0106289 A1 5/2006 Elser et al.  
 2006/0111642 A1 5/2006 Baura et al.  
 2006/0155172 A1 7/2006 Rugg  
 2006/0173363 A1 8/2006 Felder et al.  
 2006/0195050 A1 8/2006 Alwan et al.  
 2006/0253005 A1 11/2006 Drinan et al.  
 2006/0255935 A1 11/2006 Scalisi et al.  
 2006/0258914 A1 11/2006 Derchak et al.  
 2006/0264730 A1 11/2006 Stivoric et al.  
 2007/0004969 A1 1/2007 Kong et al.  
 2007/0027365 A1 2/2007 Kosted  
 2007/0060800 A1 3/2007 Drinan et al.  
 2007/0185390 A1 8/2007 Perkins et al.  
 2007/0229350 A1 10/2007 Scalisi et al.  
 2007/0232351 A1 10/2007 Scalisi et al.  
 2007/0233403 A1 10/2007 Alwan et al.  
 2007/0255115 A1 11/2007 Anglin et al.  
 2007/0255122 A1 11/2007 Vol et al.  
 2007/0270668 A1 11/2007 Childre et al.  
 2007/0276270 A1\* 11/2007 Tran ..... A61B 5/0022  
 600/508  
 2007/0282177 A1 12/2007 Pilz  
 2007/0293781 A1 12/2007 Sims et al.  
 2008/0058670 A1 3/2008 Mainini  
 2008/0154098 A1 6/2008 Morris et al.  
 2008/0255438 A1 10/2008 Saidara et al.  
 2008/0269625 A1 10/2008 Halperin et al.  
 2008/0281164 A1 11/2008 Stebor et al.  
 2008/0281633 A1 11/2008 Burdea et al.  
 2008/0287751 A1 11/2008 Stivoric et al.  
 2008/0312511 A1 12/2008 Osler et al.  
 2009/0066519 A1 3/2009 Martino  
 2009/0099967 A1 4/2009 Yokota et al.  
 2009/0103722 A1 4/2009 Anderson et al.  
 2009/0105605 A1 4/2009 Abreu  
 2009/0112071 A1 4/2009 LeBoeuf et al.  
 2009/0119119 A1 5/2009 Scalisi et al.  
 2009/0131759 A1 5/2009 Sims et al.  
 2009/0137881 A1 5/2009 Ebert et al.  
 2009/0146822 A1 6/2009 Soliman  
 2009/0174603 A1 7/2009 Scalisi et al.  
 2009/0189807 A1 7/2009 Scalisi et al.  
 2009/0216556 A1 8/2009 Martin et al.  
 2009/0234198 A1 9/2009 Vorse  
 2009/0267829 A1 10/2009 Mitchell et al.  
 2009/0287120 A1 11/2009 Ferren et al.  
 2009/0289844 A1 11/2009 Palsgrove et al.  
 2009/0292214 A1 11/2009 Ferren et al.  
 2009/0292219 A1 11/2009 Pringle et al.  
 2009/0292222 A1 11/2009 Ferren et al.  
 2009/0312660 A1 12/2009 Guarino et al.  
 2009/0315767 A1 12/2009 Scalisi et al.  
 2009/0318778 A1 12/2009 Dacso et al.  
 2010/0016745 A1 1/2010 Crump et al.  
 2010/0030036 A1 2/2010 Mottram et al.  
 2010/0036277 A1 2/2010 Austin  
 2010/0055734 A1 3/2010 Everson  
 2010/0060642 A1 3/2010 Chhapparwal et al.  
 2010/0109875 A1 5/2010 Ayon et al.  
 2010/0121156 A1 5/2010 Yoo  
 2010/0168589 A1 7/2010 Banet et al.  
 2010/0179438 A1 7/2010 Heneghan et al.  
 2010/0198024 A1 8/2010 Elazari-Volcani et al.

2010/0214090 A1 8/2010 Sartini et al.  
 2010/0222686 A1 9/2010 Fisher et al.  
 2010/0231391 A1 9/2010 Dror et al.  
 2010/0261981 A1 10/2010 Griffioen  
 2010/0302042 A1 12/2010 Barnett et al.  
 2010/0312071 A1 12/2010 Schenk  
 2010/0321189 A1 12/2010 Gibson  
 2011/0004072 A1 1/2011 Fletcher et al.  
 2011/0015504 A1 1/2011 Yoo  
 2011/0025493 A1 2/2011 Papadopoulos et al.  
 2011/0028798 A1 2/2011 Hyde et al.  
 2011/0028799 A1 2/2011 Hyde et al.  
 2011/0029038 A1 2/2011 Hyde et al.  
 2011/0060215 A1 3/2011 Tupin, Jr. et al.  
 2011/0087113 A1 4/2011 Mack et al.  
 2011/0105853 A1 5/2011 Rakowski et al.  
 2011/0105862 A1 5/2011 Gies et al.  
 2011/0106627 A1 5/2011 LeBoeuf et al.  
 2011/0129131 A1 6/2011 Avinash et al.  
 2011/0139088 A1 6/2011 Gordon  
 2011/0160548 A1 6/2011 Forster  
 2011/0190595 A1 8/2011 Bennett et al.  
 2011/0201898 A1 8/2011 Benco et al.  
 2011/0201904 A1 8/2011 Cusimano Reaston et al.  
 2011/0205069 A1 8/2011 Liu  
 2011/0215935 A1 9/2011 Zehavi  
 2011/0218450 A1 9/2011 Haefner et al.  
 2011/0224503 A1 9/2011 Cusimano Reaston et al.  
 2011/0237906 A1 9/2011 Kabakov  
 2011/0251469 A1 10/2011 Varadan  
 2011/0298619 A1 12/2011 O'Hare et al.  
 2012/0009943 A1 1/2012 Greenberg  
 2012/0029345 A1 2/2012 Mahfouz et al.  
 2012/0029359 A1 2/2012 Sterzer et al.  
 2012/0050046 A1 3/2012 Satorius  
 2012/0059235 A1 3/2012 Davies  
 2012/0068848 A1 3/2012 Campbell et al.  
 2012/0078127 A1 3/2012 McDonald et al.  
 2012/0089492 A1 4/2012 Scalisi et al.  
 2012/0119905 A1 5/2012 Scalisi et al.  
 2012/0122480 A1 5/2012 Scalisi et al.  
 2012/0146795 A1 6/2012 Margon et al.  
 2012/0146796 A1 6/2012 Margon et al.  
 2012/0150327 A1 6/2012 Altman et al.  
 2012/0179004 A1 7/2012 Roesicke et al.  
 2012/0179012 A1 7/2012 Saffarian  
 2012/0215077 A1 8/2012 Geissler et al.  
 2012/0242501 A1 9/2012 Tran et al.  
 2012/0245439 A1 9/2012 Andre et al.  
 2012/0245464 A1 9/2012 Tran  
 2012/0266251 A1 10/2012 Birtwhistle et al.  
 2012/0296176 A1 11/2012 Herbst  
 2012/0299731 A1 11/2012 Triener  
 2012/0316455 A1 12/2012 Rahman et al.  
 2012/0316456 A1 12/2012 Rahman et al.  
 2012/0316458 A1 12/2012 Rahman et al.  
 2012/0316471 A1 12/2012 Rahman et al.  
 2012/0330112 A1 12/2012 Lamego et al.  
 2013/0014706 A1 1/2013 Menkes  
 2014/0182519 A1 7/2014 Tupin, Jr.

FOREIGN PATENT DOCUMENTS

DE 102009040198 A1 3/2011  
 EP 1 957 999 A2 8/2008  
 EP 2 172 052 A1 4/2010  
 EP 2 255 216 A2 12/2010  
 GB 2 347 503 A 9/2000  
 GB 2 387 465 A 10/2003  
 JP S55-166481 U 11/1980  
 JP 2003310077 A 11/2003  
 JP 3099981 U 4/2004  
 JP 2004-528123 A 9/2004  
 JP 2005102959 A 4/2005  
 JP 2005170370 A 6/2005  
 JP 2007-236251 A 9/2007  
 JP 2008-526388 A 7/2008  
 JP 2009178142 A 8/2009  
 JP 2009-219867 A 10/2009

(56)

**References Cited**

FOREIGN PATENT DOCUMENTS

JP	2011-103812	A	6/2011
JP	2011-142866	A	7/2011
JP	2012-045373	A	3/2012
JP	2012-146029	A	8/2012
KR	2003-0061157	A	7/2003
WO	87/006113	A1	10/1987
WO	02/056274	A1	7/2002
WO	03/023439	A2	3/2003
WO	03/025826	A2	3/2003
WO	2005/041131	A2	5/2005
WO	2005/058192	A2	6/2005
WO	2005/104930	A1	11/2005
WO	2007/062244	A2	5/2007
WO	2008057883	A2	5/2008
WO	2008/104810	A1	9/2008
WO	2008/148051	A1	12/2008
WO	2009/061328	A1	5/2009
WO	2009/088688	A2	7/2009
WO	2009/105243	A2	8/2009
WO	2009/106896	A2	9/2009
WO	2010/019307	A1	2/2010
WO	2010/118173	A2	10/2010
WO	2011149565	A1	12/2011
WO	2012140547	A1	10/2012
WO	2012146957	A1	11/2012
WO	2013118121	A1	8/2013

OTHER PUBLICATIONS

Mar. 3, 2017 (CA) Office Action—App. 2,930,264.  
 Jul. 11, 2017 (JP) Office Action—App. 2016-529969.  
 Taoufik et al., The Ultra Wide Band Radar System Parameters in Medical Application, Journal of Electromagnetic Analysis and Applications, 2011, 3, 147-154.

Jun. 25, 2014—(PCT) International Search Report and Written Opinion—App PCT/US2014/022257.  
 Sep. 16, 2014—(PCT) International Search Report and Written Opinion—App PCT/US2014/022273.  
 Oct. 9, 2014—(PCT) International Search Report and Written Opinion—App PCT/US2014/037518.  
 Sep. 24, 2015—U.S. Final Office Action—U.S. Appl. No. 13/840,298.  
 Aug. 26, 2015—U.S. Non-Final Office Action—U.S. Appl. No. 13/838,988.  
 Mar. 11, 2015—U.S. Non-Final Office Action—U.S. Appl. No. 13/840,298.  
 Dec. 4, 2015—U.S. Non-Final Office Action—U.S. Appl. No. 14/086,721.  
 Dec. 16, 2015—(NZ) First Examination Report—App 712541.  
 Apr. 5, 2016—(AU) Patent Examination Report No. 1—App 2014237545.  
 Sep. 24, 2015—(PCT) International Preliminary Report on Patentability—App PCT/US2014/022273.  
 Sep. 15, 2015—(PCT) International Preliminary Report on Patentability—App PCT/US2014/022257.  
 May 2, 2016—U.S. Final Office Action—U.S. Appl. No. 13/838,988.  
 May 12, 2016—U.S. Non-Final Office Action—U.S. Appl. No. 13/840,298.  
 May 23, 2016 (NZ) Examination Report—App. 712541.  
 Jun. 6, 2016—(KR) Office Action—App 10-2015-7029908.  
 Aug. 9, 2016 (JP) Office Action—App. 2016-500935.  
 Sep. 28, 2016 (CA) Office Action—App. 2,907,170.  
 Sep. 30, 2016 (AU) Patent Examination Report No. 1—App. 2014237542.  
 Oct. 20, 2016 (KR) Office Action—App. 10-2015-7029903.  
 Nov. 4, 2016 (NZ) Further Examination Report—App. 712541.  
 Nov. 9, 2016 (JP)—Notification of Reasons for Refusal—App. 2016-500929.  
 Dec. 8, 2016 (CA) Office Action—App. 2,907,167.  
 Apr. 24, 2017 (NZ) Examination Report—App. 719948.

\* cited by examiner

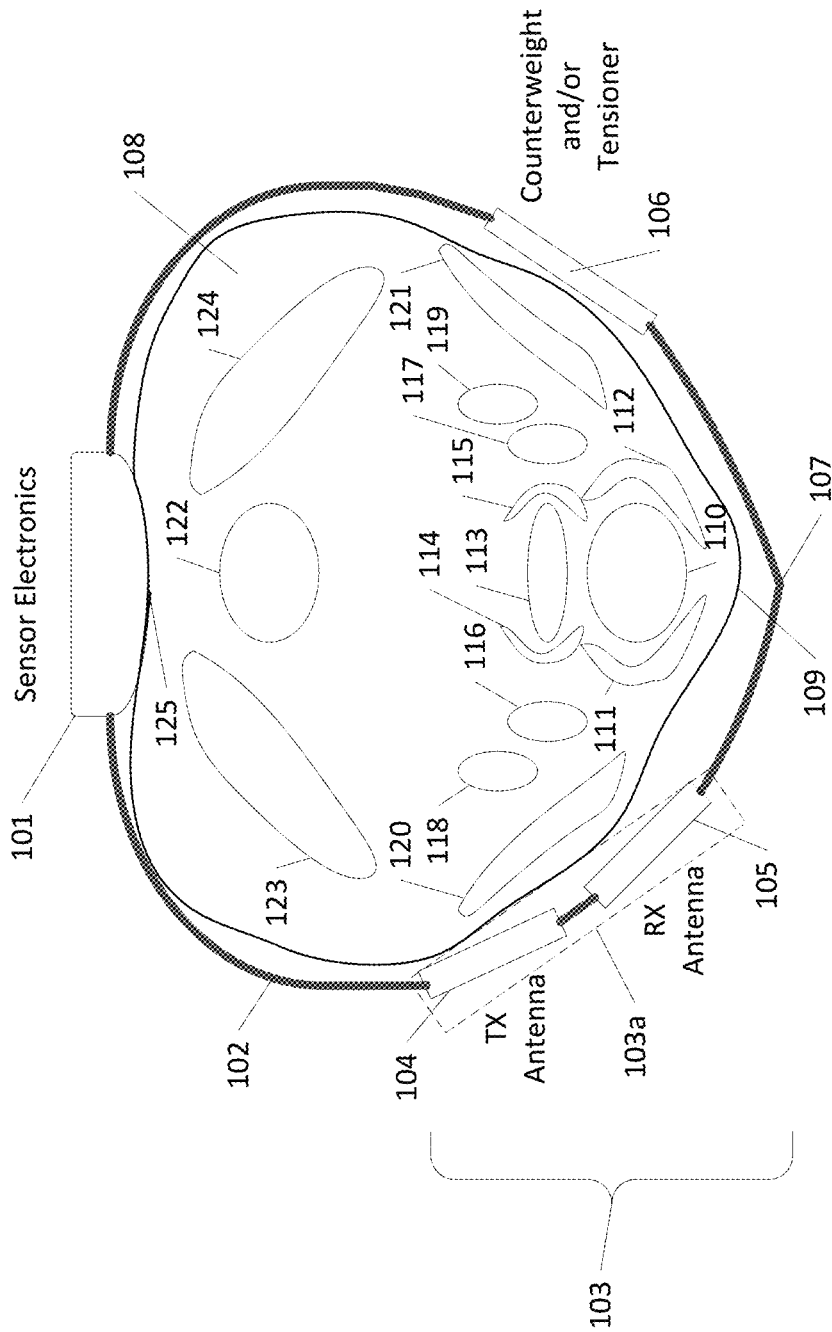

Figure 1

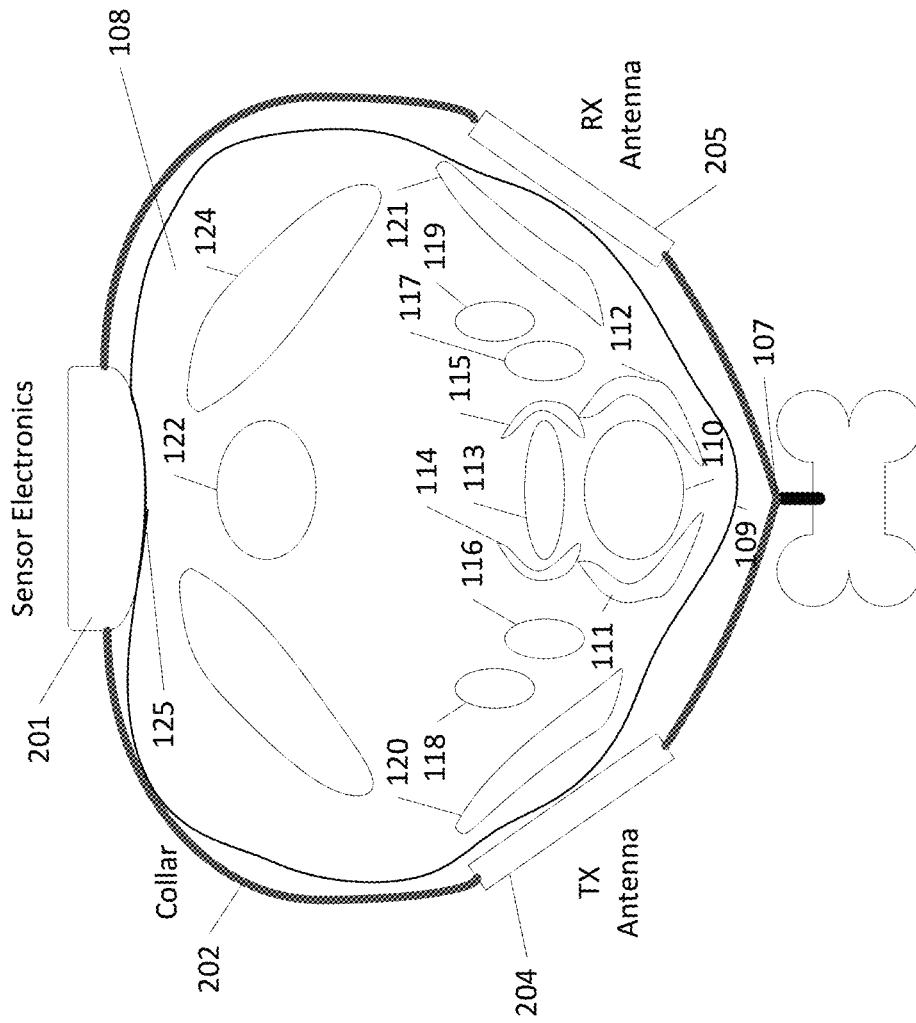
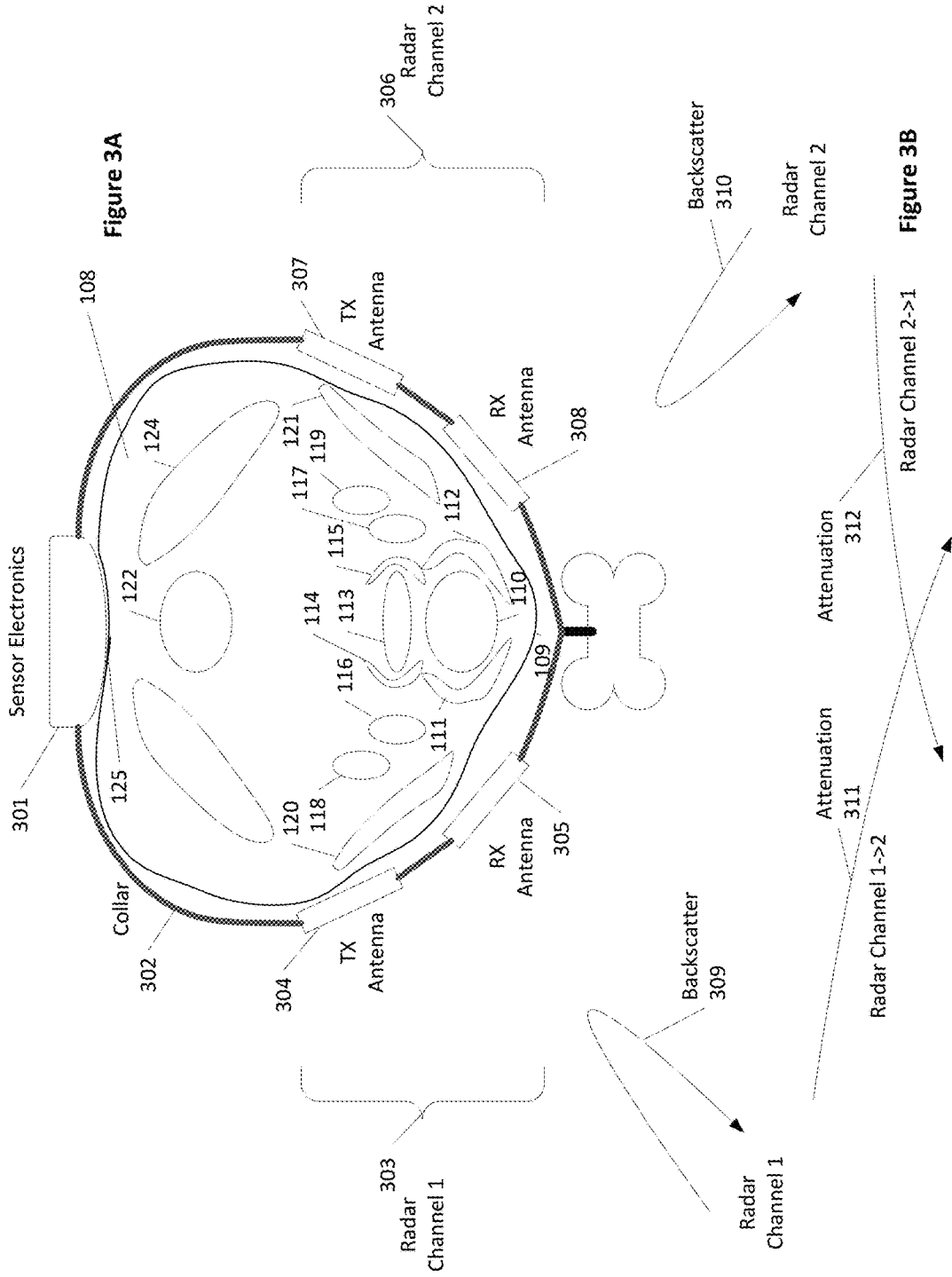
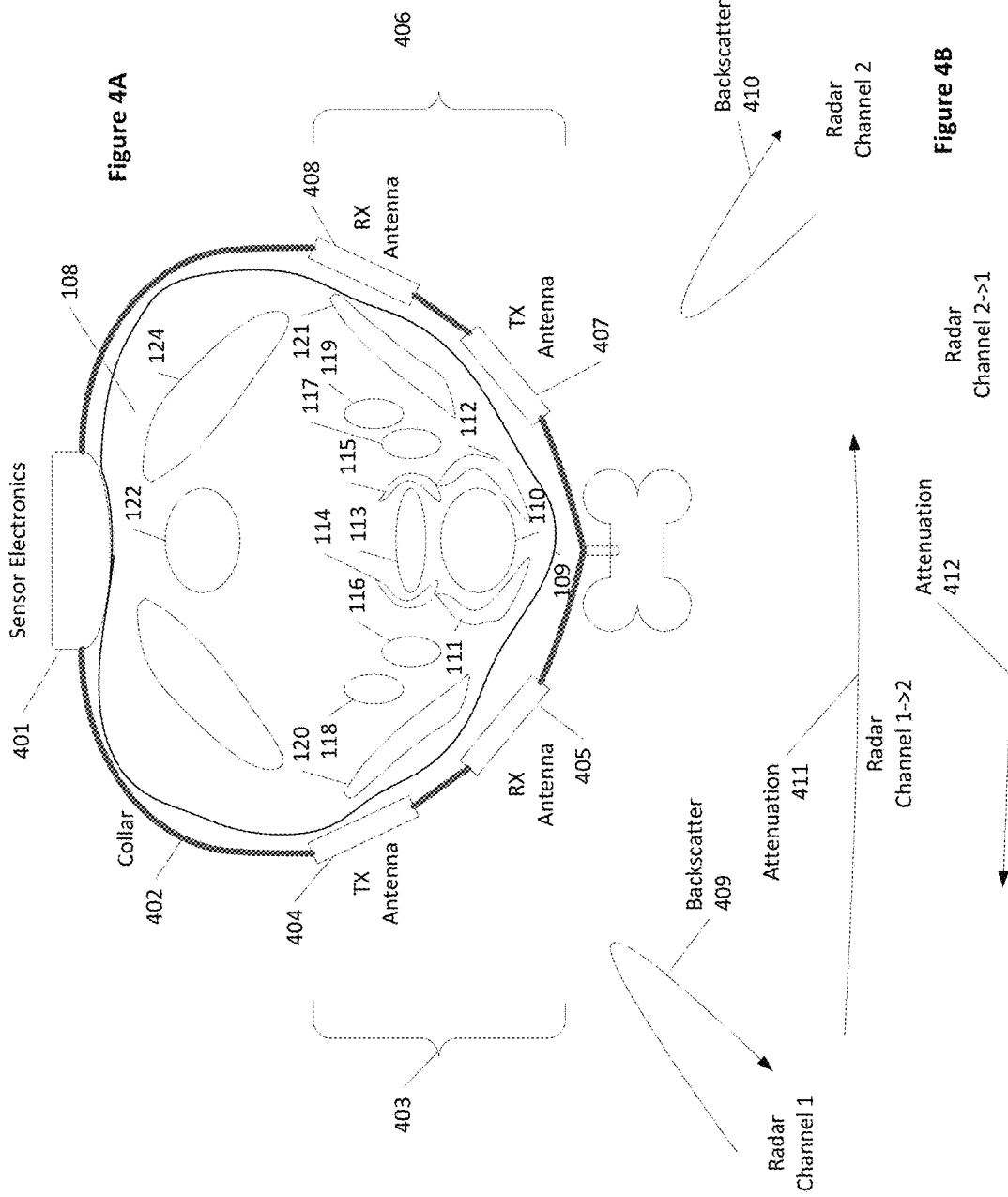
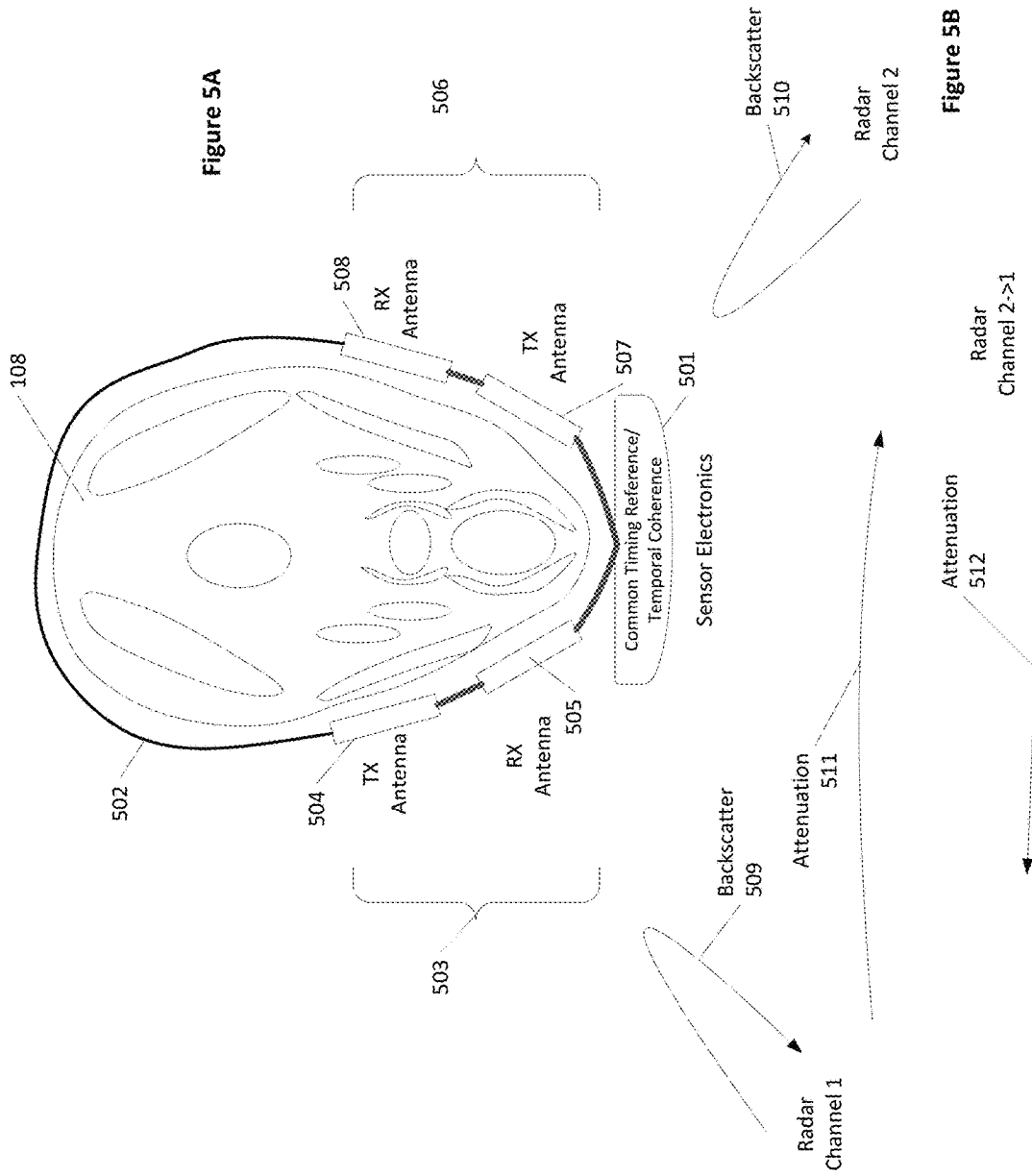

Figure 2









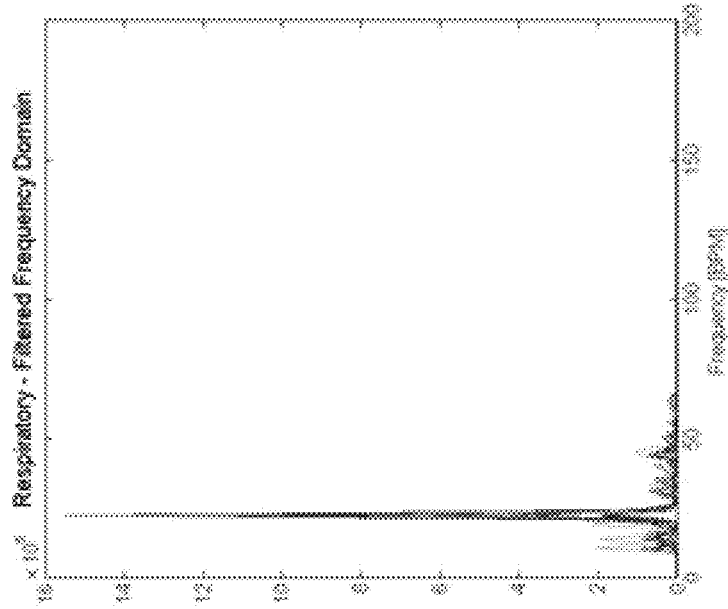

Figure 6B

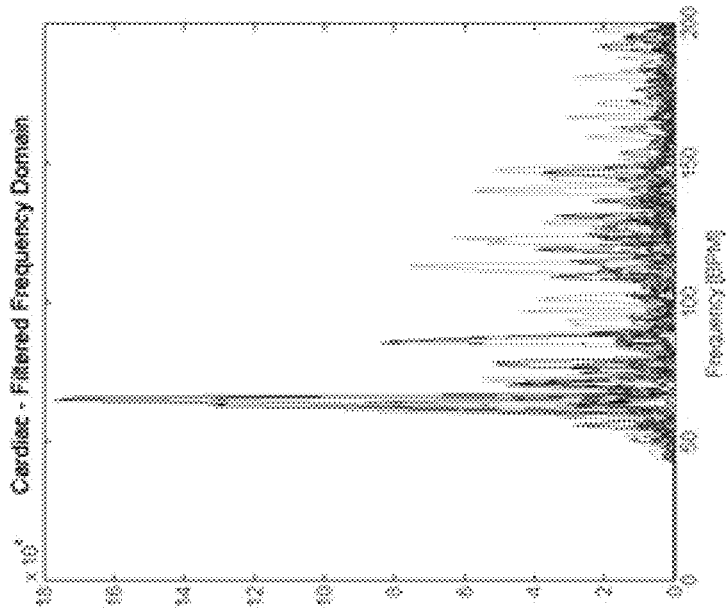

Figure 6A

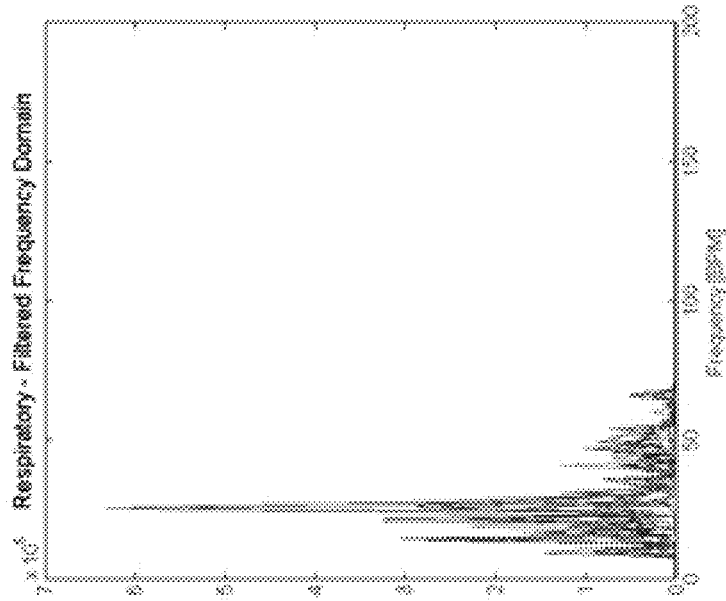

Figure 7B

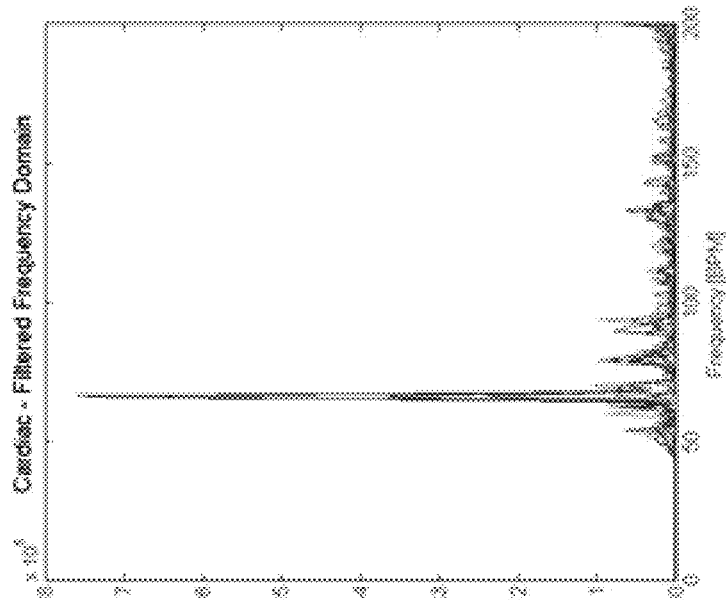

Figure 7A

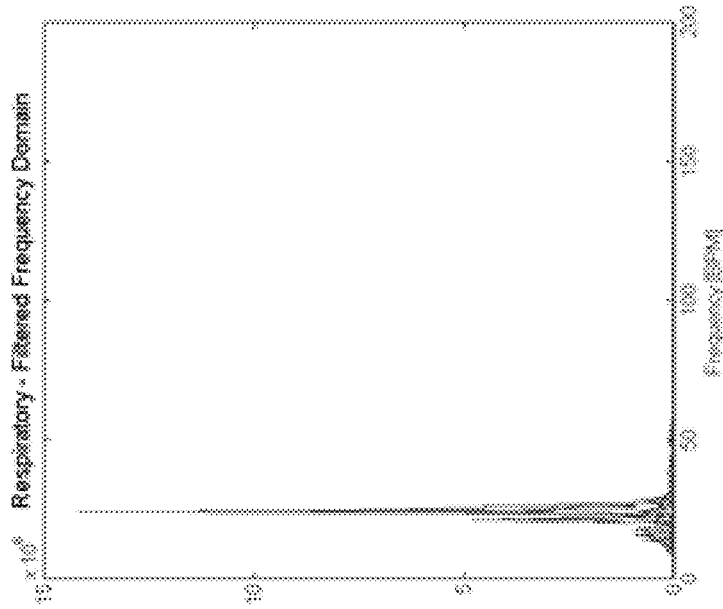

Figure 8B

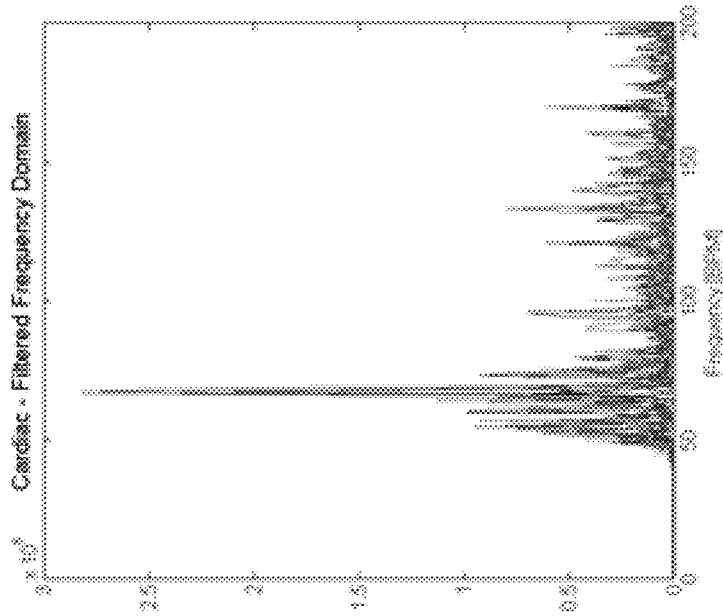

Figure 8A

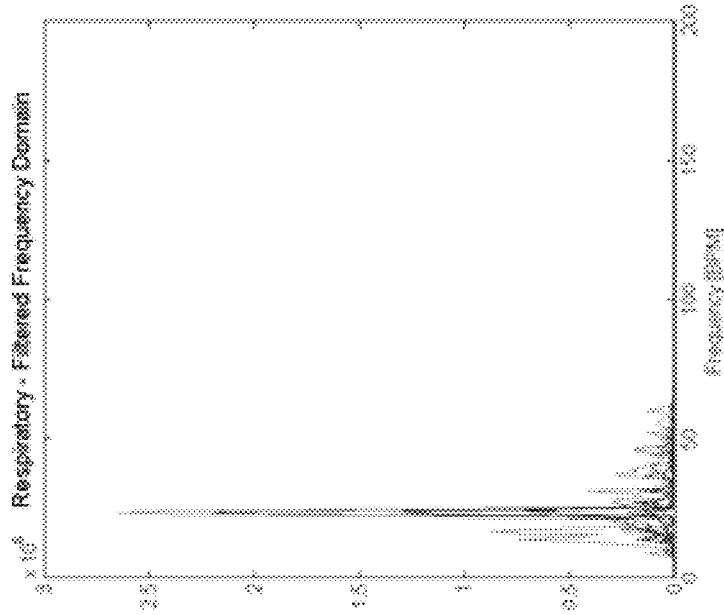

Figure 9B

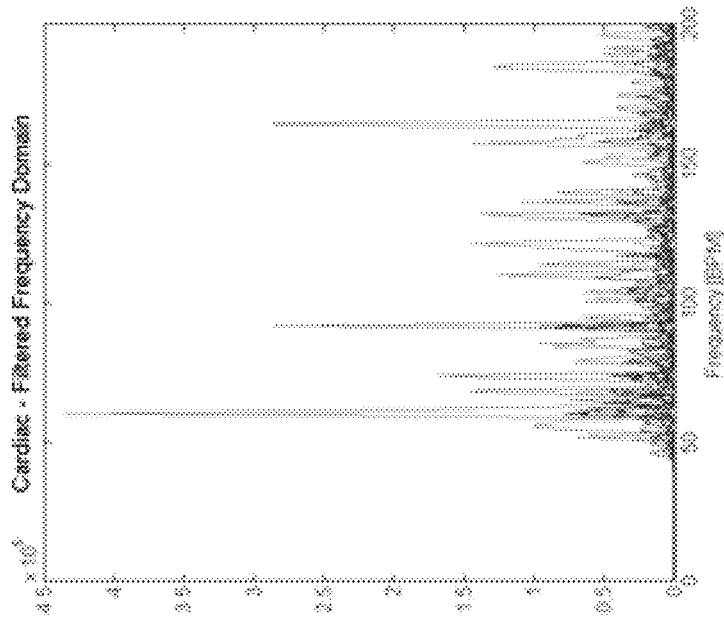

Figure 9A

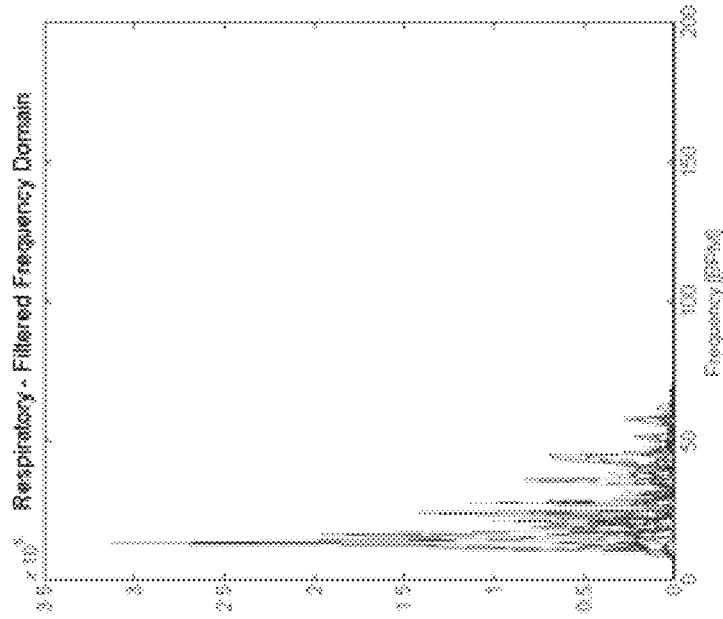

Figure 10B

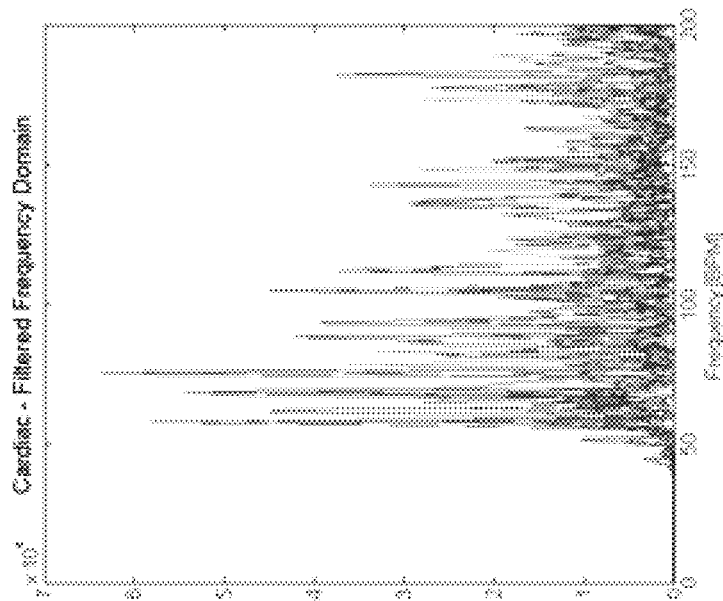

Figure 10A

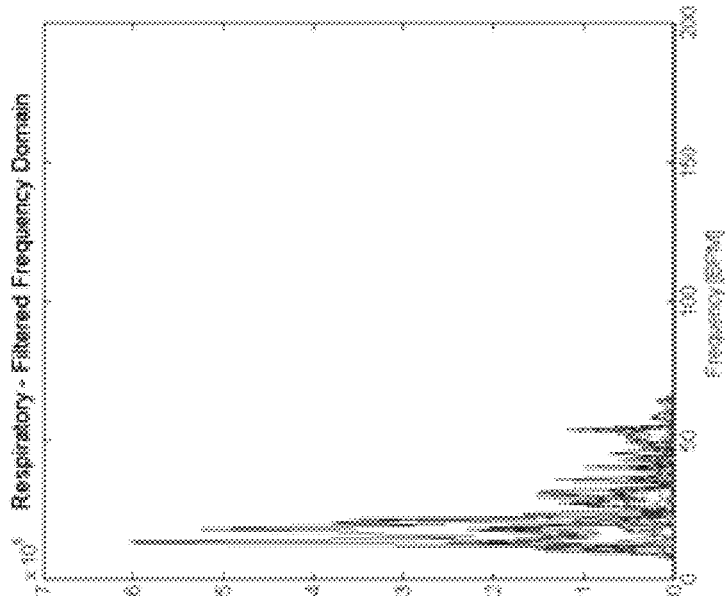

Figure 11B

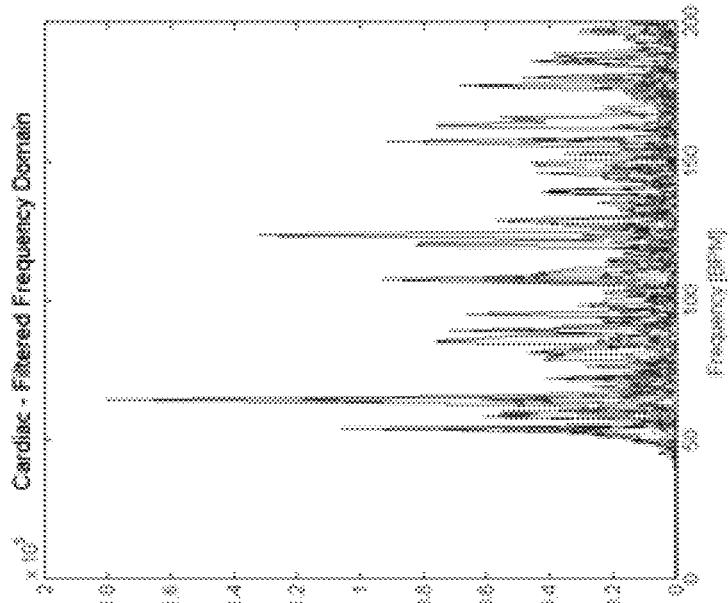

Figure 11A

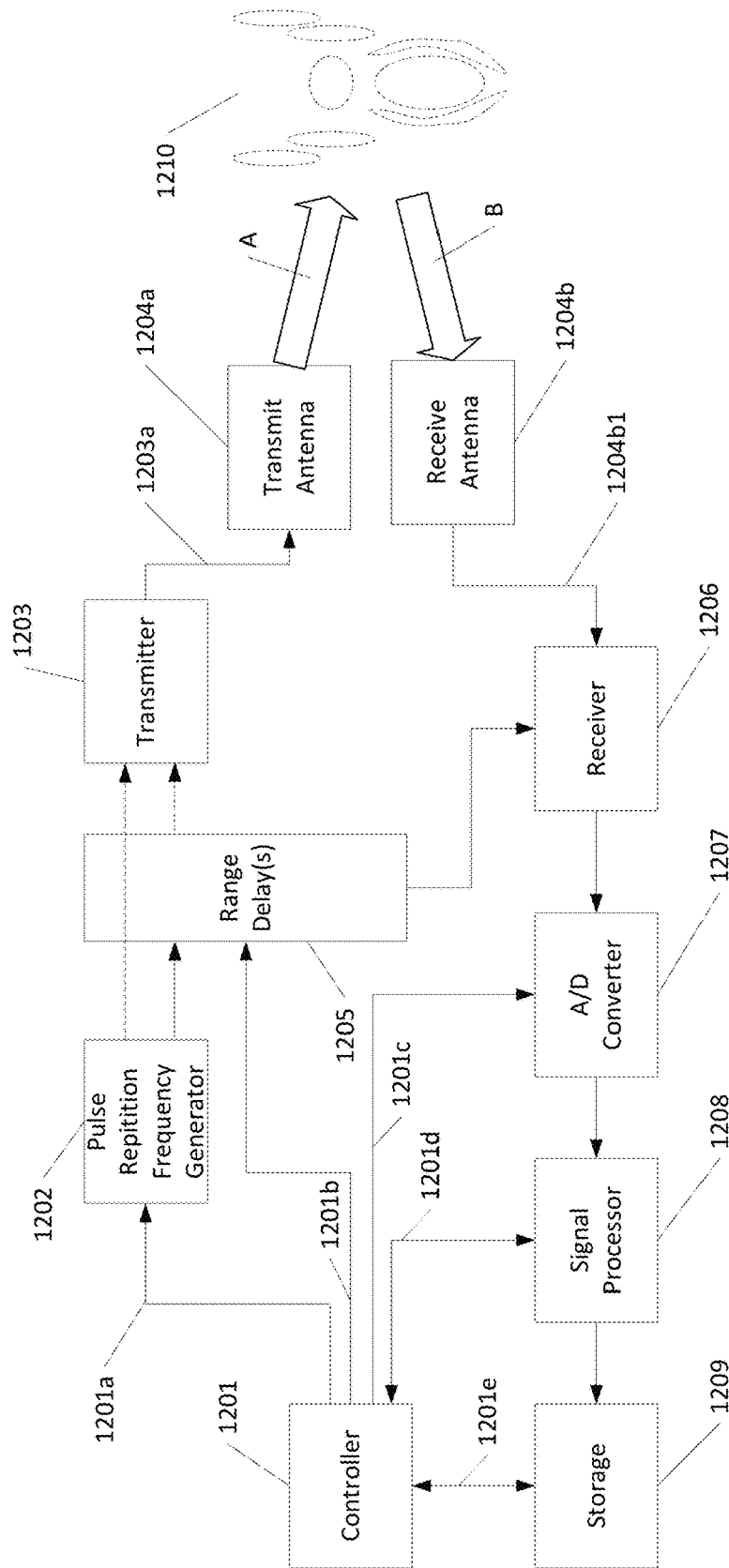

Figure 12



## ANIMAL HEALTH AND WELLNESS MONITORING USING UWB RADAR

### RELATED APPLICATION INFORMATION

This application is a continuation of U.S. application Ser. No. 14/086,721, filed Nov. 21, 2013, which claims priority to U.S. application Ser. No. 61/729,298, filed Nov. 21, 2012, all of which are incorporated herein by reference in their entirety.

### BACKGROUND

#### 1. Technical Field

Aspects of this disclosure relate to the use of radar in monitoring physiological conditions of mammals.

#### 2. Related Art

Animals, like humans, can suffer from injury or illness, negatively impacting their health. Timely detection of changes in health through either regular or event driven episodic monitoring of physiological processes can enable veterinary intervention, potentially reducing the effects of an adverse condition, improving the quality of life, and prolonging life. In particular, cardiac and respiratory monitoring provides useful information on the health of an animal and these types of information are commonly used to diagnose, treat, and manage the animal.

Animals can represent a large financial and often, emotional investment. Health monitoring can help optimize veterinary care to protect that investment and provide peace of mind to the owner. Monitoring is applicable to a wide range of animals, including feed stock, breeding stock, exotic/endangered species, animal athletes, performing animals, and domestic pets. Monitoring can be accomplished whether the animal is in the wild, in captivity (e.g. a zoo or animal park), in a pasture or free-range, in a barn or stable, at home or in the yard, in a pen or a crate.

Animal health monitoring is challenging. Many familiar sensor technologies—e.g. ECG, pulse oxygen, ultrasound, and temperature, require direct skin contact, making them impractical for use with animals having fur or feathers. They may also require that the sensor be positioned on a specific location on the body which again may be impractical. For example, assuming prior removal of the fur, pulse ox sensors typically need to be placed on thin anatomical structures such as ears, making them prone to loss through scratching, rubbing, or shaking. Similarly, ECG sensors are usually placed on the torso, in proximity to the heart and the Einthoven triangle, making them prone to loss through scratching, rubbing, or shaking. Finally, there is no sensor currently available that is capable of providing a direct, unobtrusive measurement of respiration—a needed metric in understanding and managing animal health.

The monitoring of respiration is currently under-appreciated in veterinary care and there are only a handful of researchers in the country studying/teaching animal pulmonology. This lack of integration into veterinary medicine is in contrast to the body of published information dating back several decades concerning the role of respiratory symptoms in the diagnosis and treatment of animal cardiac and respiratory disease. One of the obstacles in integrating respiratory monitoring into veterinary practice is the lack of appropriate non-invasive sensors. Most veterinarians are forced to rely on manual observations—watching the animal, to obtain respiratory data. These observations are of limited use and complicated by the visit to the vet as this usually leads to animal anxiety and elevated cardiopulmonary functions that

are not representative of the animal's true underlying health. Respiratory monitoring is not viewed as an important parameter because of the difficulty in obtaining accurate data.

Respiratory monitoring in the animal's nature environment—e.g. at home for a pet or in a pasture for a horse or cow, would be a benefit to veterinary medicine as the data would be more representative of the animal's actual state of health. This data could be used to help treat animals with known medical problems as well as identify animals that may be developing medical problems. There are a number of medical problems that exhibit respiratory symptoms, including heart disease, heart murmur, pulmonary edema, pulmonary fibrosis, sleep apnea, COPD, asthma, larynx paralysis, kennel cough (bordetella), and others. Specific to domestic pets, respiratory monitoring would be important with brachycephalic dogs—breeds with short muzzles such as bulldogs, cavaliers, pugs, Boston terriers, Boxers, Pekingese, shih tzu, etc. These breeds have a high incidence of respiratory problems and are inefficient “panthers”, leading to inflamed respiratory tracts and laryngeal problems as well as making them much more susceptible to heat stroke. Timely identification of respiratory distress would enable earlier and less complicated/expensive intervention and reduce the risk to the animal.

As discussed above, many medical monitoring technologies are impractical or unusable with animals. Doppler radar approaches, whether CW or pulsed, have been investigated as a technique for collecting cardiopulmonary data. They have generally relied on off-body or non-contact monitoring where the Doppler radar sensor is separated from the subject by an air gap and thus, does not make direct contact with the patient. Due to the large difference between the relative dielectric properties of the primary propagation medium (air, where  $\epsilon_r \approx 1$ ) and living tissue ( $\epsilon_r \approx 50$ ), most of the RF energy is reflected at the skin surface with little energy propagating into the interior of the body to interrogate the internal organs. Any energy that does propagate into the torso and is subsequently reflected by the internal organs is greatly reduced by internal tissue absorption as well as a second transition across the skin-air boundary, resulting in little energy from the anatomical target making it back to the receiver. Low returns equate to marginal data.

A common technique for isolating a specific physiological process involves combining Doppler with auto-correlation. Auto-correlation samples the time-domain waveform and correlates the Nth pulse with a period of time after the Nth pulse where the period is centered on the anticipated rate of the specific physiological process under review based on the Doppler results. High correlation coefficients equate to greater confidence that the system has locked onto the specific physiological process. An externally defined threshold is often used to determine adequate correlations and thus, sufficient target acquisition.

Because of the strong surface component associated with respiration (typically 1 cm chest wall displacement in an average adult male), off-body techniques can collect reasonable pulmonary data but those physiological processes that do not have strong surface components, such as cardiac activity, are difficult to detect and measure with

Doppler. Another limitation of Doppler is its general inability to distinguish motion associated with more than one physiological process when those processes operate at similar rates. For example, in subjects experiencing bradycardia, the cardiac rate will approach and sometime drop below the respiratory rate, making it difficult for Doppler to distinguish the two processes from each other.

## SUMMARY

Once or more aspects relate to a collar with an ultra-wideband radar. A housing contains sensor electronics and the transmit and receive antennas are located separate from the housing around the circumference of the collar. A first example of the collar includes a first transmit antenna and a first receive antenna. A second example of the collar adds a second transmit antenna and a second receive antenna. The antennas may be positioned to obtain position and movement information from various internal structures including a carotid artery, a jugular vein, and muscles surrounding an esophagus and trachea.

## BRIEF DESCRIPTION OF DRAWINGS

FIG. 1 is an illustrative example of a monostatic radar on the neck of an animal in accordance with one or more embodiments.

FIG. 2 is an illustrative example of a bistatic radar on the neck of an animal in accordance with one or more embodiments.

FIG. 3A is a first illustrative example of a multistatic radar on the neck of an animal in accordance with one or more embodiments. FIG. 3B shows signal paths for the multistatic radar of FIG. 3A.

FIG. 4A is a second illustrative example of a multistatic radar on the neck of an animal in accordance with one or more embodiments. FIG. 4B shows signal paths for the multistatic radar of FIG. 4A.

FIG. 5A shows an illustrative example of a multistatic radar on a narrow neck of an animal in accordance with one or more embodiments. FIG. 5B shows signal paths for the multistatic radar of FIG. 5A.

FIGS. 6A and 6B are charts showing cardiac and respiratory rates from a sternal position of a UWB sensor on an animal in accordance with one or more embodiments.

FIGS. 7A and 7B are charts showing cardiac and respiratory rates from a right carotid position of the UWB sensor

FIGS. 8A and 8B are charts showing cardiac and respiratory rates from right larynx position of the UWB sensor

FIGS. 9A and 9B are charts showing cardiac and respiratory rates from posterior neck position of the UWB sensor

FIGS. 10A and 10B are charts showing cardiac and respiratory rates from right femoral position of the UWB sensor

FIGS. 11A and 11B are charts showing cardiac and respiratory rates from right shoulder position of the UWB sensor

FIG. 12 shows an illustrative example of a UWB sensor.

## DETAILED DESCRIPTION

The following description relates to configurations of ultra-wideband (UWB) sensors for obtaining physiological information from mammals. Specifically, aspects of the disclosure pertain to the use of UWB sensors as medical radar to the extent they use very low power Ultra Wide Band (UWB) radio frequency (RF) energy. In practice, the UWB medical radar emits a narrow pulse of electromagnetic energy, which propagates into a body. As the energy enters the body, small amounts of the incident energy are reflected back to the device. The reflections are due to the differences in dielectric properties of the illuminated tissues and organs. The reflected energy is then received and processed using application-specific signal processing algorithms to extract information on the type, location, size, and motion of the

illuminated tissues and organs. It is appreciated that the greater the dielectric constant between illuminated tissues and organs increases the reflection (or backscatter) of the electromagnetic pulse.

Examples of UWB medical radar systems are found, for instance, in U.S. Pat. No. 7,725,150 to Tupin, Jr. et al. and U.S. Pat. No. 8,463,361 to Tupin, Jr., both assigned to LifeWave, Inc. of Los Altos, Calif., whose contents are expressly incorporated by reference to their entirety.

Ultra-wideband radar overcomes one of the limitations found with Doppler radar because of the extremely fine radial resolution (<5 mm) inherent with UWB radar, allowing the UWB sensor to more easily isolate different physiological processes based on their unique locations within the patient. The sensor can focus on one or more depths using traditional range sweep techniques and, if the sensor is configured as an array, further focal processing techniques based on beam-steering and beam-forming can be applied.

A contact-based UWB medical sensor for monitoring the health of animals has several distinct advantages over Doppler and off-body monitoring. The UWB radar does not need direct skin contact or coupling gels, allowing it to collect useful physiological data through fur or feathers yet by maintaining contact with fur or feathers. As such, the large reflective losses associated with the skin-air interface are significantly reduced. Second, assuming the electronics are sufficiently protected from the environment (e.g., sealed against rain and moisture or otherwise moisture resistant), the radar may operate when wet or dirty.

For instance, a UWB radar system may be placed on an animal's collar as shown in FIG. 1. FIG. 1 shows a cross-sectional view of an animal's neck and the collar being worn by the animal. The UWB radar system of FIG. 1 includes sensor electronics 101 in a housing and antennas 103 including a transmit antenna 104 and a receive antenna 105. The antennas 104 and 105 may be placed together in a singular housing 103a or may be housed separately. One advantage of housing the antennas 104 and 105 together is that the direction each antenna faces may be fixed with respect to the other antenna.

These components of the UWB radar system may be co-located at a single location or may be placed around the collar 102 as shown in FIG. 1 and connected by wires, cables, traces on a circuit board (rigid or flexible), or other known electrical connecting techniques. If co-located, an example of a size of the combination of the antennas 104 and 105 and the sensor electronics 101 may be 7.4 cm×2.3 cm×1.8 cm and weigh 29 g.

The UWB radar system monitors movement of different structures based on their different dielectric constants relative to surrounding structures or tissues. The change in location of the interfaces between these structures is monitored by the UWB radar system and is subsequently analyzed through known analysis techniques of UWB radar signals.

Aspects of this disclosure relate to configurations of the UWB radar system to provide improved signals for analysis. For reference, FIG. 1 shows the animal's neck 108 with skin 109, trachea 110 with surrounding muscles 111, 112, esophagus 113 with surrounding muscles 114, 115, carotid arteries 116, 117, jugular veins 118, 119, spinal column 122, and various other muscles (including lower muscle groups 120, 121, and upper muscle groups 123 and 124).

In one example, the UWB radar system with sensor electronics 101 and antennas 103 may be co-located (namely, the sensor electronics 101 module being positioned radially outward from antennas 103 relative to neck 109) as

a monostatic radar structure and hang off collar at a bottom-most position **107** relative to the animal's neck **108**, closest to the trachea **110**.

In another example, as shown in the configuration of FIG. **1**, sensor electronics **101** are positioned at the top of the neck **108** with the antennas **103** located on the side of neck **108**, also as a monostatic radar structure. Here, by placing transmit antenna **104** and receive antenna **105** closer to carotid artery **116** and jugular vein **118**, the beam from the transmit antenna **104** and returning to receive antenna **105** may encounter fewer dialectically different structures when located at the position shown in FIG. **1** then when located at position **107**. This reduction in the number of dialectically different structures reduces backscatter signals from those different structures.

As depicted, collar **102** may include a counterweight **106** that may be approximately the weight of antennas **103** balance the UWB radar system and attempt to maintain antennas **103** at their side placement around the neck **108**.

Alternatively or in addition to counterweight **106**, a tensioner may be used to maintain a relatively constant tension on collar **102** to help position antennas **103** on the side of the neck **108**.

Further, as larger animals have stronger neck muscles (for instance muscles **123**, **124**), these muscles in some instances may form a recess **125** upward of spinal column **122**. The inside shape of sensor electronics **101** may be convex to allow at least some nestling in the concave recess formed by muscle groups **123** and **124**.

By placing antennas **103** and aside position as shown in FIG. **1**, accurate readings from the animal's carotid artery **116** and/or jugular vein **118** may be obtained. Depending on the type of animal, the antennas **103** may be angled relative to neck **108** and/or to each other to allow for illumination of relevant structures and collection of backscattered signals from those structures. For instance, to concentrate solely on carotid artery **116**, the receive antenna **105** may be moved closer to transmit antenna **104** to receive the stronger backscatter signals roughly in line with the radiated beam from transmit antenna **104** plan. Alternatively, to concentrate on carotid artery **116** and the movement of muscles **114** and **115** surrounding esophagus **113**, receive antenna **105** may be moved farther away from transmit antenna **104**. Further, to also include signals from the movement of muscles **111** and **112** surrounding trachea **110**, the receive antenna **105** may be moved further from transmit antenna **104**. In these examples, the various muscle groups may be monitored surrounding the trachea **110** as the trachea's cartilage may not reflect the UWB pulses and the movement of the cartilage is not detectable directly.

In many applications across a range of species, the UWB radar sensor can be placed within or on a collar or harness where the choice of the garment and specific sensor placement upon or within the garment is driven by the desired medical data, the need to locate the sensor in the proximity of the key primary and alternative secondary anatomical structures required to obtain the desired data, and the need to secure the sensor to the animal such that it is unlikely to be dislodged or removed during normal activity. In addition, the shape of the sensor and its antennas can be modified to take advantage of the anatomy to assist with placement and maintain position.

Actual signal processing and display of results does not have to be co-located with the sensor and in fact, remote processing and display might be highly desirable. The data can be processed (partially or completely) locally using an embedded processor (for instance, microcontroller or dis-

crete signal processor) or wirelessly transferred to another processing platform—dedicated base station, smart phone, tablet, PC, or the cloud using a conventional wireless transfer system (transmitter in the sensor electronics **101** to transmit a signal to of receiver over, for instance a Wi-Fi connection). The display can be a digital readout on a panel built into the base station or take advantage of the GUI capabilities of any number of consumer electronics.

Of the various limitations described herein, a collar **102** allows collection of basic cardiopulmonary data without the need to be directly over the heart and lungs. The collar with its UWB radar system collects data primarily from the carotid arteries in the neck, as well as physiological data associated with motion of the larynx, trachea, and esophagus. Data from these structures enables monitoring of consumption—i.e. food and water, vomiting and regurgitation, as well as enabling the detection of choking and vocalization—e.g. barking, or other processes involving the larynx and trachea based on analyses of received signals including identification of the frequency components of the signals, the magnitude of those frequency components, and how those signals change over time. Other sensor technologies may be added to the assembly to support data fusion for improved accuracy, reliability, and noise reduction.

Further, an additional counterweight (e.g., the animal's tag or other collar attachment) may be provided at location **107** to provide a weight that may further aid in aligning the sensor electronics **101** and antennas **103**.

FIG. **2** shows another configuration of sensor electronics **201** and the antennas. In FIG. **2**, transmit antenna **204** is located on a first side of neck **108** and receive antenna **205** is located on a symmetrically opposite side of neck **108**. Here, the antennas **204** and **205** may be symmetrically distributed around the circumference of the neck **108** to maintain an even weight distribution on collar **202**. One example of this configuration would have the sensor electronics **101** in the depression over the spinous process **125**—see FIGS. **1** and **2**, enabling easy and consistent placement of the sensor electronics **201**. Unlike the anterior of the neck where many animals have a wattle and are sensitive to any object, this location typically has less fat tissue, less loose skin, and has less anatomical variation within a specific species or breed.

The configuration of transmit antenna **204** being separate from receive antenna **205** FIG. **2** is commonly referred to as a bistatic radar architecture. In the minimal separation case, both the TX and RX antennas may be located along the spine while in the limit, they could be located on either side of the larynx.

In FIG. **2**, the receive antenna **205** may receive backscatter from some structures inside neck **108**. For structures that have a strong dielectric difference from surrounding structures, the amplitude of the backscatter signals may predominate the received collection of signals. However for structures that have a less significant dielectric difference from surrounding structures, the resultant backscatter from these less significant dielectric differences is weaker. Thus, when attempting to monitor movement of different structures relative to each other where the dielectric constants of these structures are relatively close to one another, monitoring backscatter signals is more difficult. In this situation, monitoring signal modification (signal amplification, attenuation, polarization, retardation or advancement, and the like) with a receive antenna **205** generally facing transmit antenna **204** is preferable.

The above bistatic of FIG. **2**, configuration could be expanded to a multistatic configuration with a corresponding

increase in weight, cost of goods, and power consumption. As shown in FIG. 3A, the sensor may include two radar channels 303 and 306, each consisting of a TX and RX pair (304/305 and 307/308, respectively), where one radar channel interrogates the right side of the neck and one radar channel interrogates the left side.

This configuration takes advantage of the symmetry in the neck to improve signal reception while reducing common noise. More radar channels may be added for additional performance improvements.

As shown in FIG. 3B, radar channel 1 303 is shown on the left side of FIG. 3A and radar channel 2 306 is shown on the right side of FIG. 3A. The backscatter signal 309 of radar channel 1 303 from transmit antenna 304 enters and then returns back through the side of neck 108 to receive antenna 305. Similarly, the backscatter signal 310 of radar channel 2 306 from transmit antenna 307 enters and then returns back through side 306 of neck 108 to receive antenna 308. Also, receive antenna 308 receives attenuation signal 311 (from radar channel 1 to radar channel 2) as originally transmitted from transmit antenna 304. Likewise, receive antenna 305 receives attenuation signal 312 (from radar channel 2 to radar channel 1) as originally transmitted from transmit antenna 307.

To permit attenuation signals 311 and 312 to be received and used by sensor electronics 301, common timing signals used to control the transmission of the UWB pulses in the multistatic UWB radar system are used in radar channel 1 and radar channel 2. For instance, when transmit antenna 304 has finished transmitting, both receive antenna 305 and receive antenna 308 may both be active (in accordance with the same or a temporally adjusted timing signal) in receiving signals scattered and/or modified by the combination of various structures in neck 108. Alternatively, transmit antenna 304 and transmit antenna 307 may transmit simultaneously in accordance with the same or temporally adjusted timing signal with one of receive antenna 305 or receive antenna 308 also being active (and likewise being responsive to the same or temporally adjusted timing signal). Finally, transmit antenna 304 and transmit antenna 307 may both transmit simultaneously and receive antenna 305 and receive antenna 308 may both receive signals simultaneously with all operations coordinated through the same or temporally adjusted timing signal. The purpose using the same or temporally adjusted timing signal in sensor electronics 301 is to provide temporal coherence for the operations of radar channel 1 303 and radar channel 2 306.

FIG. 4A shows a similar structure to that of FIG. 3A in which sensor electronics 401 controls radar channel 1 403 (with transmit antenna 404 and receive antenna 405) and greater channel 2 406 (with transmit antenna 407 and receive antenna 408). Here, the locations of the transmit antenna and receive antenna of radar channel 2 406 are flipped relative to the locations of transmit antenna 404 and receive antenna 405. While backscatter signal 409 of radar channel 1 is similar to that shown in FIG. 3B, backscatter signal 410 is reflected more upwards than backscatter signal 310 of FIG. 3B (which is reflected more downwards). Also, attenuation signal 411 from transmit antenna 404 to receive antenna 408 is generally more horizontal than attenuation signal 311. Similarly, attenuation signal 412 from transmit antenna 407 to receive antenna 405 is also generally more horizontal than attenuation signal 312.

As with the sensor electronics 301 of FIG. 3A, sensor electronics 401 of FIG. 4A may also use temporally coherent timing signals to allow the multistatic operation of the transmit and receive antenna components of FIG. 4A.

FIG. 5A shows a configuration similar to that of FIG. 4A but with an animal having a narrower neck 108. FIG. 5A shows collar 502, sensor electronics 501 (with the common timing reference providing temporal coherence among radar channel 1 503 and radar channel 2 506), transmit antennas 504 and 507, receive antennas 505 and 508. FIG. 5B shows backscatter signals 509 and 510 and attenuation signals 511 and 512.

In all cases (including monostatic, bistatic, and multistatic), the location, orientation, and antenna characteristics of the paired TX and RX antennas for each radar channel may be designed to allow convergence of the TX and RX antenna bore sights onto the anatomical structure of interest while maintaining sufficient beamwidth at the structure of interest.

As described above, a counterweight may be integrated to minimize the potential for collar rotation while a tensioning device (springs or clips or elastically deformable materials) may be added to maintain constant pressure against the animal's neck 108, minimizing the noise caused by motion at the sensor/skin interface. Also, it is important to note that the sensor electronics and antennas do not need to be co-located as the electronics can connect to the antennas via cables or flexible circuit boards. Either of these connection techniques can be embedded into the collar itself as long as the connecting media is relatively homogeneous to minimize RF reflections.

A harness—e.g. a modified walking harness, has the advantage of allowing one or more radars to interrogate various anatomical regions of interest or to enable more sophisticated signal processing by isolating on a particular organ. For example, if the UWB radar sensor has at least one channel proximal to the heart, advanced cardiac biometrics can be obtained, including stroke volume, cardiac output, and changes in blood pressure. Similarly, if the UWB radar sensor has one channel proximal to main right and left nodes of the lungs, the system can check for asymmetrical breathing patterns.

The UWB radar is not limited to the torso for collecting cardiopulmonary data as there are many alternative locations on the animal that can be exploited, particularly for obtaining cardiac data. For example, good quality cardiac data can be collected by positioning the UWB sensor in proximity of the carotid arteries to take advantage of the expansion and contraction in the radius of the arteries throughout the cardiac cycle. In addition, positioning the sensor on the neck has been shown to provide reasonable and quantifiable respiratory information.

Various porcine animal models (weights between 30-50 kg) have been studied thank you to develop new human cardiopulmonary monitoring systems. In these studies, a UWB radar sensor was placed to the left of the animal's sternum, proximal to the heart and collected cardiopulmonary data in parallel with other reference monitors. Data from the UWB radar sensor was processed with proprietary signal processing algorithms and the results correlated against the data from the reference monitors to determine the efficacy of the radar sensor. The UWB sensor demonstrated the ability to measure cardiac and pulmonary rate, detect changes in cardiac stroke volume, measure CPR compressions, and determine the status of the circulatory system across a variety of cardiac conditions.

Most recently, the ability of the sensor to measure cardiopulmonary rates in small animals using dogs weighing less than 10 kg as the test subjects has been studied. This ability along with the capabilities previously demonstrated and described above, enables a variety of animal monitoring applications. During the tests, the cardiac rate was manually

observed to be approximately 65 BPM, while the respiration rate was manually observed to be approximately 20 BPM.

In the first test, the UWB radar sensor was placed on the left side of the animal's rib cage, approximately level with the heart while the animal was prone. As can be seen in FIGS. 6A and 6B, the cardiac rate and pulmonary rate as calculated with an FFT were readily discernible and matched manual measurements.

In the second test, the UWB radar sensor was placed on the right side of the animal's neck, over the carotid artery with the axis of the sensor parallel to the longitudinal axis of the artery. As can be seen in FIGS. 7A and 7B, the cardiac rate and pulmonary rate as calculated with an FFT were readily discernible and matched manual measurements.

In the third test, the UWB radar sensor was placed on the right side of the animal's neck, immediately adjacent to the larynx with the axis of the sensor parallel to the longitudinal axis of the trachea. As can be seen in FIGS. 8A and 8B, the cardiac rate and pulmonary rate as calculated with an FFT were readily discernible and matched manual measurements. This position is particularly interesting because it also provides a view of the larynx, trachea, and esophagus.

In the fourth test, the UWB radar sensor was placed on the posterior of the animal's neck, immediately over the spinous process with the axis of the sensor parallel to the longitudinal axis of the spine. As can be seen in FIGS. 9A and 9B, the cardiac rate and pulmonary rate as calculated with an FFT were readily discernible and matched manual measurements.

In the fifth test, the UWB radar sensor was placed on the right hind leg, immediately over the right femoral artery and below the pelvic joint, with the axis of the sensor parallel to the longitudinal axis of the artery. As can be seen in FIGS. 10A and 10B, the pulmonary rate as calculated with an FFT was readily discernible and matched manual measurements. The cardiac rate was less discernible and somewhat obscured by other noise sources.

In the sixth test, the UWB radar sensor was placed on the right fore leg, immediately over the right auxiliary artery and below the shoulder joint, with the axis of the sensor parallel to the longitudinal axis of the artery. As can be seen in FIGS. 11A and 11B, the pulmonary rate as calculated with an FFT was readily discernible and matched manual measurements. The cardiac rate was less discernible and somewhat obscured by other noise sources.

To summarize these basic cardiopulmonary tests with the UWB medical radar on a canine model, the cardiac and pulmonary rates as calculated from the UWB radar data were generally discernible and matched manual measurements. In several instances, the cardiac rate was less discernible than pulmonary and somewhat obscured by other noise sources, potentially including muscle twitch from the animal and the researcher holding the sensor in position. Similarly, in several instances, the pulmonary rate varied slightly over 2-3 BPM, most likely due to the resolution of the FFT (~0.732 BPM) and the expected variability in respiration from its voluntary component (observed as minor breath-holding). It is interesting to note that the strength of the cardiac signal was typically 10-13 dB below that of the pulmonary signal while neck and torso positions produced more discernible cardiopulmonary data with minimal noise.

FIG. 12 shows a conventional configuration for a UWB radar system as known in the art. The UWB radar system of U.S. Pat. No. 7,725,150 is incorporated herein by reference. The controller 1201 generates the timing and control signals 1201a, 1201b, 1201c, 1201d, and 1201e to synchronize and manage the rest of the system. It also accepts internal

feedback signals from the other subsystems, accepts external control inputs from an operator, and has the capability of providing data outputs to the operator or medical record system. The controller can be realized using an integrated processor and associated circuitry.

Based on timing and control signals 1201a from the controller 1201, the pulse repetition frequency (PRF) generator 1202 creates the baseband pulse train used by the transmitter 1203 and, after range delay  $\Delta t$  1205, by the receiver 1206. Alternately, both the transmitter 1203 and the receiver 1206 may receive a delayed signal from the pulse repetition frequency generator 1202. Further, the delay applied to either or both of the transmitter 1203 and the receiver 1206 may be fixed or variable.

Since the pulse train is common to both the transmitter and receiver subsystems and allows them to operate synchronously, the system is a time-coherent radar system. In practice, a voltage-controlled oscillator (VCO) operating at a nominal but only exemplary output frequency of 2 MHz in or associated with the PRF generator supplies the pulse train. Randomized pulse-to-pulse dither can be added to the output of generator 2 by injecting a noise signal from a noise signal source (not shown) into the VCO control port. The random dither causes spectral spreading to reduce the probability of interfering with other electronic devices as well as provide a unique transmit coding pattern per unit, allowing multiple units to operate in close proximity without substantial concern for mutual interference.

Transmitter 1203 generates a series of low-voltage, short-duration pulses 1203a (in one embodiment, less than 200 ps) based on the pulse train from the PRF generator 1202. In practice, differentiating the edges of a pulse train having extremely fast rising and falling edges creates the sub-nanosecond pulses. Through the combination of the transmitter and the antenna, the short duration pulses are converted into an ultra-wide band spectrum signal centered in the RF/microwave frequency bands in accordance with FCC R&O 02-48.

In one embodiment, the transmitter 1203 and receiver 1206 share a common antenna 1204. In another embodiment, the antennas are separated into transmit antenna 1204a and receive antenna 1204b. For the transmitter, the antenna 1204a couples the short pulses from the transmitter 1203 to the environment, as illustrated at A, to a patient. Subsequently, reflections B are received from the environment and fed to the receiver 1206. Various antenna configurations may be used including: commercially available horns and flat resonators, simple magnetic dipoles, and a magnetic dipole or "loop" antenna(s) with a diameter selected to optimize the transmission and reception of UWB signals. For example, a loop antenna with a diameter of 4 cm fabricated from 24-gauge solid copper wire was used in conjunction with a UWB system operating with a 10 dB bandwidth of 1.5 Ghz to 3.4 Ghz.

Based on timing and control signals 1201b from the controller 1201 and the pulses originating from the PRF generator 1202, the range delay  $\Delta t$  1205 generates a delayed version of the PRF timing signal. The output of the range delay triggers a sample-and-hold circuit, described subsequently, in the receiver 1206 where the delay value is chosen to compensate for fixed electrical delays within the system and focus data collection to those reflections originating from a specific depth within the body. The range delay is extremely flexible and, in conjunction with the controller, can generate a large range of delay profiles to accommodate a variety of signal processing requirements.

There are two delay modes used to collect medical data—range gate mode and range finder mode. In range gate mode, the depth within the body that corresponds to the area for which physiological data is to be extracted is fixed and a large number of samples are collected at that depth over a period of multiple seconds in one example, providing information on relative changes within the body. The depth can then be changed and the process repeated. In contrast, when operating in range finder mode, the depth is swept repeatedly over a finite range of interest, with samples collected at each depth. Range gate mode provides detailed information at the depth of interest while range finder mode is used to quickly collect data over a range of depths. A range delay circuit supports both range gate and range finder modes. In practice, the range delay circuit can be realized using a 12-bit digital-to-analog converter (DAC), an operational amplifier, used to realize functions, and a one-shot multivibrator. The one-shot multivibrator (an LMC555 can be used, as one example) generates a delayed version of the transmitted pulse train in response to signals received on its two control inputs—trigger and hold-off. The pulse train from the PRF generator **1202** is the trigger signal and causes the one-shot multivibrator to initiate a single pulse cycle for each pulse in the pulse train. The hold-off voltage determines the period of the pulse. By varying the hold-off voltage, different pulse periods, and thus different delay values, can be generated. The amount of delay is set by both analog and digital controls. The analog controls set the minimum delay value and the allowable range of control while the digital controls are used to dynamically adjust the actual delay value, delay sweep rate, and resolution of delay control.

In practice, a 12-bit data value—Data<sub>x</sub>, corresponding to the desired delay is sent from the controller **1201** to the DAC. The DAC produces a voltage V<sub>x</sub> where: V=4.096 Volts×(Data<sub>x</sub>/4096).

The DAC output voltage and a DC voltage are added together in a summing junction and the sum is amplified and fed to the hold-off control input of the one shot. The DC voltage level, in conjunction with the amplifier gain, set the minimum delay value and the allowable range of control. Both the DC voltage level and gain settings are controlled by manual adjustment of potentiometers. A delay range of 5 ns has been proven to yield good quantitative data in cardiopulmonary applications and corresponds to a depth range of approximately 12 cm into the body. Other delay range values of up to 10 ns have also shown to produce usable data sets.

The receiver **1206** processes the raw reflections received from the antennas **1204b** over line **1204b1** in the analog domain to optimize the signals of interest. For cardiopulmonary data, this includes suppressing the high-strength static return signals and amplifying the motion artifacts. Receiver **1206** may be based on a dual-channel balanced receiver architecture where the transmitter pulses are capacitively coupled from the output of the transmitter **1203** into both receive channels via RF. Splitter and the antenna **1204** is connected or otherwise coupled to one channel. The balanced receiver architecture provides a high degree of common mode rejection as well as differential gain. The common mode rejection provides a significant amount of attenuation to signals common to both channels thus minimizing interference from the transmit signal with the desired receive signal. The differential gain inherent in this architecture amplifies signals unique to either channel thus the received signal, being unique to the channel, is amplified.

Both channels can use an ultra-fast sample-and-hold (S/H) circuit, each triggered by the delayed impulse train created by the pulse generator using the delayed pulse train

over the line from the range delay circuit  $\Delta t$  **5** of FIG. **12**. The active sampling window is set at approximately 320 ps in one example and can be easily modified by selectively changing the value of a single passive component. The outputs of the two S/H circuits are integrated over multiple samples in integrator elements to improve the signal-to-noise ratio. The integrated samples feed the inverting and non-inverting inputs of an instrumentation amplifier, attenuating the transmitted signal and amplifying the received signal.

As illustrated in FIG. **12**, A/D converter **1207** (ADC) is controlled by controller **1201** through control lines **1201c**. The controller sets the sample rate, sample resolution, and start/stop timing for the sampling process based on the mode of operation. The ADC digitizes the enhanced analog motion reflections from the receiver **1206**, translating the enhanced reflected energy into a series of discrete digital values. As one example in range gate mode, 16,000 samples per second at 16-bits per sample may be used.

The digitized signal from the A/D converter **1207** is then processed to extract pertinent physiological information in signal processor **1208** per FIG. **12**. The signal processing block is extremely flexible and, as mentioned previously, can accommodate a wide variety of algorithms in support of different medical applications. In addition the algorithm can be implemented using parallel, serial, or hybrid parallel/serial architecture. The choice of a specific architecture is left to those skilled in the art and will depend on the application and other system constraints. The controller manages the signal processing operations through control path **1201d**.

The resultant physiological data is displayed on a user interface (not shown). This can include tracings of amplitude versus time for one or more depths of interest, power spectral density for one or more depths of interest, time domain and frequency domain histograms for a range of depths, numerical values for heart and/or lung rates, as well as the associated confidence factors for the displayed data, as described subsequently. The controller **1201** of FIG. **12** converts the data from the signal processor to an operator-friendly format through control path **1201e** for display on the user interface.

What is claimed is:

1. A collar comprising:

- a processor configured to control generation of an ultra-wideband radar signal and reception of resultant signals;
- a transmit antenna configured to output the ultra-wideband radar signal directed at biological tissue, the transmit antenna having an associated beam width, the transmit antenna located at a first circumferential position on the collar; and
- a receive antenna configured to receive the resultant signals based on a reflection of the ultra-wideband radar signal from the biological tissue, the receive antenna having an associated beam width, the receive antenna located at a second circumferential position on the collar, the second circumferential position different from the first circumferential position,

wherein the transmit antenna is located at a fixed angle relative to the receive antenna to maximize a magnitude associated with the resultant signals such that the beam width of the transmit antenna is configured to overlap with the beam width of the receive antenna at the biological tissue.

13

- 2. The collar of claim 1, comprising:  
a housing containing the processor, the housing located at  
a fourth circumferential position on the collar, the  
fourth circumferential position on the collar different  
from the first circumferential position and the second  
circumferential position. 5
- 3. The collar of claim 2, comprising:  
a second housing,  
wherein the housing containing the processor is a first  
housing, and 10  
wherein the transmit antenna and the receive antenna are  
located in the second housing.
- 4. The collar of claim 1, comprising:  
a tensioner located at a third circumferential position on  
the collar, the third circumferential position different  
from the first circumferential position and the second  
circumferential position. 15
- 5. The collar of claim 1,  
wherein the transmit antenna is a first transmit antenna,  
wherein the receive antenna is a first receive antenna, and  
wherein the collar comprises:  
a second transmit antenna; and  
a second receive antenna. 20
- 6. The collar of claim 5,  
wherein the first transmit antenna is circumferentially  
closer to a housing containing the processor than the  
first receive antenna, and  
wherein the second transmit antenna is circumferentially  
closer to the housing than the second receive antenna. 25
- 7. The collar of claim 5,  
wherein the first transmit antenna is circumferentially  
closer to a housing containing the processor than the  
first receive antenna, and  
wherein the second receive antenna is circumferentially  
closer to the housing than the second transmit antenna. 30
- 8. The collar of claim 5,  
wherein, after the first transmit antenna outputs the ultra-  
wideband signal, the first receive antenna is configured  
to receive the resultant signals. 35
- 9. The collar of claim 5,  
wherein, after the first transmit antenna outputs the ultra-  
wideband signal, the second receive antenna is config-  
ured to receive the resultant signals. 40
- 10. The collar of claim 5,  
wherein, after the first transmit antenna outputs the ultra-  
wideband signal, the first receive antenna and the  
second receive antenna are configured to receive the  
resultant signals. 45

14

- 11. The collar of claim 5,  
wherein, after the first transmit antenna and the second  
transmit antenna output the ultra-wideband signal, the  
first receive antenna is configured to receive the resul-  
tant signals.
- 12. The collar of claim 1,  
wherein the ultra-wideband signal output from the trans-  
mit antenna is configured to illuminate at least one of  
a carotid artery or a jugular vein, and  
wherein the resultant signals contain information relating  
to a position and motion of the at least one of the carotid  
artery or the jugular vein.
- 13. The collar of claim 1,  
wherein the ultra-wideband signal output from the trans-  
mit antenna is configured to illuminate muscles prox-  
imate to at least one of a trachea or an esophagus, and  
wherein the resultant signals containing information relat-  
ing to a position and motion of the muscles proximate  
to the at least one of the trachea or the esophagus.
- 14. The collar of claim 1, wherein the fixed angle is based  
on a type of tissue associated with the biological tissue.
- 15. The collar of claim 1, wherein the fixed angle is based  
on one or more structures between the biological tissue and  
at least one of the transmit antenna or the receive antenna.
- 16. The collar of claim 1, wherein the fixed angle is based  
on a type of physiological signal associated with the bio-  
logical tissue.
- 17. The collar according to claim 1, comprising:  
a range-delay circuit comprising:  
a digital-to-analog converter;  
an amplifier; and  
a multivibrator.
- 18. The collar according to claim 1, comprising:  
an analog-to-digital converter,  
wherein the processor is configured to:  
receive a digitized signal from the analog-to-digital  
converter; and  
extract pertinent physiological information from the  
digitized signal.
- 19. The collar of claim 1, wherein the processor is  
configured to:  
inject a noise signal from a noise signal source into the  
ultra-wideband radar signal, wherein the noise signal is  
configured to cause spectral spreading and provide a  
unique transmit coding pattern for the transmit antenna.
- 20. The collar of claim 1, comprising:  
a counterweight that is approximately a same weight as  
the transmit antenna and the receive antenna.

\* \* \* \* \*